



# PROLYTE GROUP

## BLACKBOOK

TECHNICAL MATTERS  
ENGLISH VERSION 2016



PROLYTE  
STRUCTURES



PROLYTE  
SYSTEMS



STAGE  
DEX



PRO  
LYFT



# PROLYTE GROUP





# BLACKBOOK CONTENTS

- INTRODUCTION 4
- 1. THE TERM: TRUSS 6
- 2. CONNECTION SYSTEMS 8
- 3. FORCES ON TRUSS 13
- 4. TYPE OF LOAD 18
- 5. SPECIFIC LOAD SCENARIOS 20
- 6. TRUSSES AND LOADS 22
- 7. CALCULATION METHODS 32
- 8. DETERMINING SAFETY FACTORS 34
- 9. LOADING TABLES 36
- 10. APPLICABLE LEGISLATION AND REGULATIONS 39
- 11. SLINGING TRUSSES 48
- 12. PRACTICAL TIPS FOR PROLYTE TRUSSES 58
- 13. WHICH HEIGHT IS WHICH? 65
- 14. PROLYTE ROOF AND OUTDOOR STRUCTURES 67
- 15. PERFORMER FLYING 78
- 16. PERSONAL SAFETY EQUIPMENT  
IN THE ENTERTAINMENT INDUSTRY 80
- 17. APPROVAL AND INSPECTION 83
- 18. MAINTENANCE AND DISCARD  
CRITERIA FOR TRUSSES 85
- 19. RULES FOR APPLICATION 90
- 20. PROLYTE CAMPUS 92
- NOTES 94



Photo: Faithless concert, Dubai

## Basic Technical Information

This BlackBook contains basic technical information about our trusses and complementary products. We will be looking at the truss with its technical properties, its potential and practical limits.

We are aware that this information is basic knowledge and cannot cover all areas.

However, although this documentation is not exhaustive, we believe it provides a good introduction to our products.

All information complies with the latest

standards and developments. The compositions and designs for aluminium trusses are described below, as well as the different types of connections, forces within the trusses and the different load types. We will discuss standards, regulations and laws relating to trusses, followed by calculation methods and loading tables.

Furthermore we describe hoisting trusses, lifting people, truss maintenance, criteria for rejection and discard, and accepted



practical rules. In our opinion, good customer service consists primarily in continuously improving the information available to users. This means that all users can select and use different truss types depending on the specific structural properties of the truss. Better and appropriate use of trusses is of great benefit both to our customers

and to us as manufacturers.

In the long term this means enhanced safety, satisfied customers and greater awareness of users when working with trusses.

Our prime objective is quality, this applies not only to our products but also to the associated information. Both are key to a successful and safe product range.

© 2016 PROLYTE GROUP

All rights reserved. No parts of this catalogue may be reproduced or published in any form or in any way, by print, photo print, microfilm or any other means without prior written permission from Prolyte Group. Though compiled with due care, no representation is made as to the truth or accuracy of measurements, data or information contained herein. Prolyte Group disclaims any liability for damage, losses or other consequences suffered or incurred in connection with the use or the measurements, data or information contained herein.

We reserve the right to alter products, codes and technical information without prior notice.

# 1. THE TERM: TRUSS

## 1.1 A SHORT HISTORICAL REVIEW

When the first lattice spans appeared in event technology in the 1970's, hardly anyone would have described a truss as follows: "A modular structural element made of aluminium tubes welded to each other, used to create temporary supporting structures for lighting and audio equipment used in event technology."

At that time anything was used, from round steel tubes to antenna masts or riveted angle profiles.

The word truss or lattice girder used to describe the wooden construction framework that was used to build houses, roofs or medieval cathedrals.

The development of trusses as we know them today began towards the end of the 1970's when the entertainment industry was searching for a simple and efficient means of manufacturing light but safe supporting structures.

Designers used know-how about spatial structures employed in bridge construction to develop today's products.

Apart from the bearing capacity, other practical considerations were important when developing trusses.

A truss is defined as:  
a spatial lattice beam:

- Made from welded round tubes.
- Composed of modular coupled parts.
- Manufactured in several standardised lengths.
- Used to support equipment in the entertainment industry.
- Supported or suspended at almost any desired point.

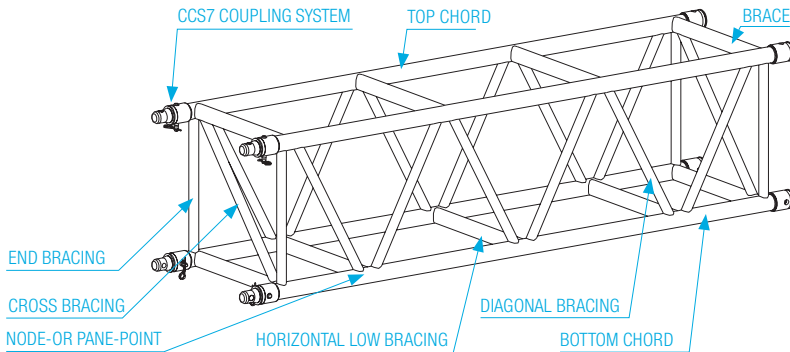
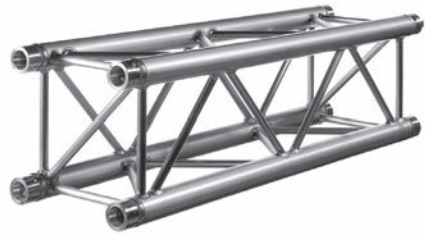



## 1.2 MATERIAL FOR TRUSSES

### Trusses are made of aluminium because:

- Aluminium has a self-weight ca. 65% less than steel.
- Aluminium is corrosion resistant and therefore requires less maintenance and no corrosion protection.
- Aluminium has a relatively high tensile strength.
- Aluminium has an attractive appearance due to its natural lustre.
- Aluminium is 100% recyclable.

### The basic elements of a truss:

- Chords or main tubes (mostly 48 - 51 mm outer diameter).
- Braces or verticals and diagonals (the webbing or lattice structure).
- Connection parts (to connect the individual structural modules).

### All trusses should have the following properties:

- Rigidity and stability appropriate for the intended use.
- A simple, reliable and quick connection system.
- Easy to handle thanks to light, compact elements.
- Efficient for application, transport and storage purposes.
- Multiple application possibilities.
- Basic information available to users on allowable load bearing capability and deflection provided in tables and diagrams.
- Robust and reliable connection parts.

Trusses are available in various geometric profiles: double chord truss (ladder), triple chord truss (triangle), quadruple chord truss in square and triangle design and various types of folding trusses. There are considerable differences between these profiles which are decisive for:

- Safety: structural rigidity and stability.
- Cost effectiveness: efficiency for connecting, storage and transport.
- Multiple applications: a broad range of uses for various construction designs with a special truss type.

Each of these designs has its specific advantages, disadvantages and fields of application. The user should carefully consider the intended purpose before selecting a system.

Prolyte manufactures trusses for almost all applications in event technology, from decorative trusses of the E-series for shops and displays, to universal trusses for trade fairs, exhibition stand construction and rental, to heavy duty trusses for the high standards of the events and stage building industry. Although a fairly new development, trusses have become an indispensable product for the contemporary event industry.



## 2. CONNECTION SYSTEMS

Trusses are manufactured in standard lengths which can be combined to provide any overall length required. It is not usual to manufacture large truss lengths in one piece, since this would make them unmanageable for handling, transport and various other applications.

### 2.1 THE FOUR MOST COMMON CONNECTION TYPES

The majority of truss modules are 2-3 metres long (6 to 10 feet). However, longer lengths are normally needed. The cost advantages of purchasing 5m modules are quickly lost in handling and transportation costs. For this reason a rapid, efficient and simple connection system is needed to connect the trusses. Although there are many types of truss connections, only a small number are used today. Connection systems with a significant market share can be divided into four categories:

#### 1. Plated connection:

The end plates are connected using bolts. These are exposed to tension far away from the main chord axes. This causes a bending moment in the joint which usually reduces the load capacity significantly.

#### Disadvantages:

- Inexact axis alignment of chord tubes to each other.
- Many individual parts.
- Complicated assembly.
- Easy to confuse vertical and horizontal plane when using square trusses.
- Tools needed to bolt parts.
- Relatively low bearing capacity.
- Danger when using bolts with low rigidity.
- Special hinges needed for tower applications.

#### Advantages:

- Universal connection system.
- Installation length equals truss length.
- Robust connection points.
- Easy to use nodal elements.

#### 2. Tube connection:

The connection is made by inserting tubes with an outside diameter smaller than the inner diameter of the chord tubes into the ends of the chord tubes. The inserted tubes are then bolted to the chord tube. The bolts are exposed to shear forces but can absorb these without any problem in contrast to the material of the chord tubes.

### CONNECTION TYPES

#### 1: PLATED CONNECTION

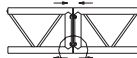
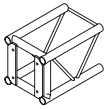

BENDING FORCE IN GUSSET PLATE

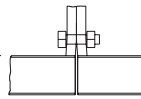

OPEN SPACE BETWEEN LOWER CHORDS

#### 2: TUBE CONNECTION

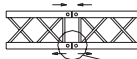
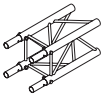

VERY HIGH CRUSHING STRESS AT THE BOLTS (BEARING TENSION)

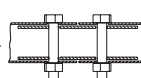

OPEN SPACE BETWEEN LOWER CHORDS

#### 3: PIN/FORK CONNECTION

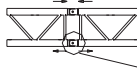
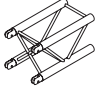

FIXED MALE / FEMALE SIDE, WEAR GIVES EXTRA DEFLECTION



#### 4: CONICAL CONNECTION

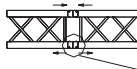
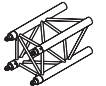

WEAR IS COMPENSATED BY SPIGOT SHAPE







Photo: Prolyte Group

The drill holes for the chord and connector tubes are therefore exposed to very high bearing stress. This type of connection is used primarily for trusses with fairly low requirements regarding bearing capacity.

#### Disadvantages:

- Relatively complicated assembly.
- Many individual parts.
- Complicated assembly.
- Head room in the connection between main tube and connecting tube.
- Tools needed.
- Rapid overloading of the connection through bearing stress.
- Tube ends are easily damaged when used frequently (means the truss may not be used).

#### Advantages:

- Universal connection system.
- Installation length equals truss length.

### 3. Pin / Fork connection:

The “female” fork is connected to the “male” pin via a cylindrical bolt. The load transmission is exerted in the axes of the main chords, the connecting bolts are exposed to shear forces.

#### Disadvantages:

- More planning needed because the direction of installation is fixed.
- Large number of different nodal elements needed.
- Installation length is shorter than truss length.
- Connecting elements can be easily damaged (means truss may not be used).
- Wear on connecting elements leads to head room between two truss elements (inner bore in the drill holes of the connecting elements cannot be repaired).

#### Advantages:

- Few individual parts.
- Very quick and simple assembly.
- No hinges needed for tower applications.



Photo: Prolyte Group, Leek, The Netherlands

#### 4. Conical connection

Connection with a solid double conical connector which is secured with a conical spigot pin in the ends of the chord tubes. The conical spigot pins are exposed to double shear force.

A fully non-positive connection is created and the force is transmitted in the axes of the main chords.

#### Disadvantages:

- Special hinges needed for tower applications.

#### Advantages:

- Universal system.
- Exact alignment of elements.
- Very quick and simple assembly.
- Connection is 100% rigid.
- Construction length corresponds to truss length.
- Compensation for wear in the drill holes using conical spigot pin.
- Connecting elements are not easily damaged and are easy to replace.



## 2.2 THE TRIANGULAR STRUCTURE OF LATTICE STRUCTURE

Why is a triangular shape the most dominant feature of a truss? A triangle is the only geometric shape which retains its shape when it is exposed to a load at connection points or joints, even if these joints are hinged. Only if one side is deformed (elongated, compressed, rolled) does a triangle lose its shape.

The behaviour of a triangular structure under load is easy to calculate and predict if the loads are exerted only in the nodal points.

The following failure processes can be identified: buckling, rupture or breaking and collapse of the unstable shape. Structural engineers must be able to determine the results of their work within very narrow tolerances in order to guarantee a safe basis for users to work with. Certain basic assumptions must be made in order to perform calculations.

Each side of a triangle should only be exposed to compression or tensile forces. Since no other influences such as flexural load are assumed, loads should be directed into the nodal points.

It should be emphasised that a truss with one or two-sided lateral bracing (at right angles to the main chord) may not be used for the same types of load as trusses with a diagonal lattice structure on all sides. For example, this applies to the truss series S36R, S52F, S52V, S66R and S66V. Without consulting a structural engineer it means that forces should impact in a plane with the diagonal lattice structure and at 90° to the plane of the support braces.

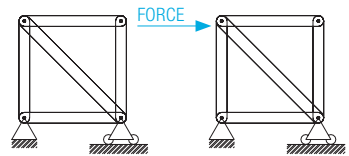
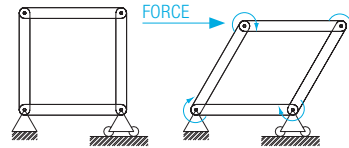
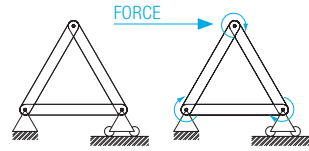

The triangle is the only geometric shape that retains its form when being loaded at the joints.

## 2.3 FOOL PROOF ASSEMBLY

All Prolyte trusses are designed as ready-to-use modules with terminated lattice structures. The end braces terminate the lattice structure of all trusses. Therefore a single truss module of a sufficient length can be used as a lifting accessory on its own. For this reason -when longer truss spans are needed- truss modules of different lengths can be assembled without the need to pay respect to the continuity of the lattice structure. Fool proof assembly for your convenience.



Photo: PROMontaje, Venezuela, XXL Roof



### 3.1 DEFINITION OF EXTERNAL AND INTERNAL FORCES

In a truss construction we can define two different types of forces.

The first type of forces we can define are external forces, which are imposed through external influences on the truss construction.

Examples of these external forces are:

- Live loading such as lighting fixtures or sound equipment, curtains, drapes.
- Dynamics caused by movement of (electrical) chain hoists.
- Environmental influences like: wind force, snow loads, ice.

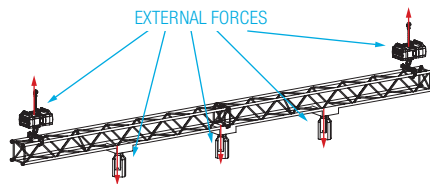

The second type of forces we can define are internal forces. Internal forces are reaction forces of the structure due to the external forces.

These internal forces can be defined inside a particular section of a truss or inside a particular section of a truss construction.

When we consider a particular section of a truss or a particular section of a truss construction, all forces must be in balance or we would have a mechanism. In other words, the sum of all the external and internal forces in a horizontal or a vertical plane needs to be zero.

When the different components of truss, such as main tubes or bracing, are not capable of bearing these internal forces the truss will fail.

In the next paragraphs we will explain by using examples from daily practice, the different kinds of external forces on a truss and what the reaction forces inside the truss will be. We will also explain how to increase the allowable forces by changing the truss components.

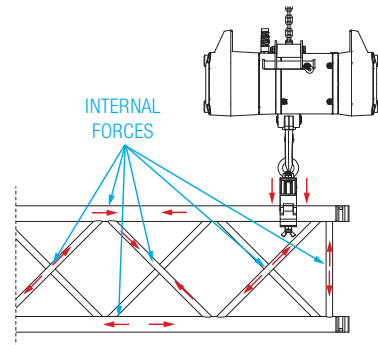

### 3.2 NORMAL FORCE

The normal force is a force which works longitudinal to the centre line of the truss and its components.

Examples of situations where normal forces become relevant:

- Towers.
- Columns.
- Rafter trusses in Roof systems.

The maximum allowable normal force is determined by the main chords of the truss.

Increasing the force can be obtained by either increasing the diameter of the main chord or increasing the wall thickness of the main chord.

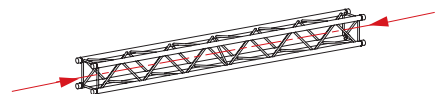

### 3. FORCES ON TRUSS

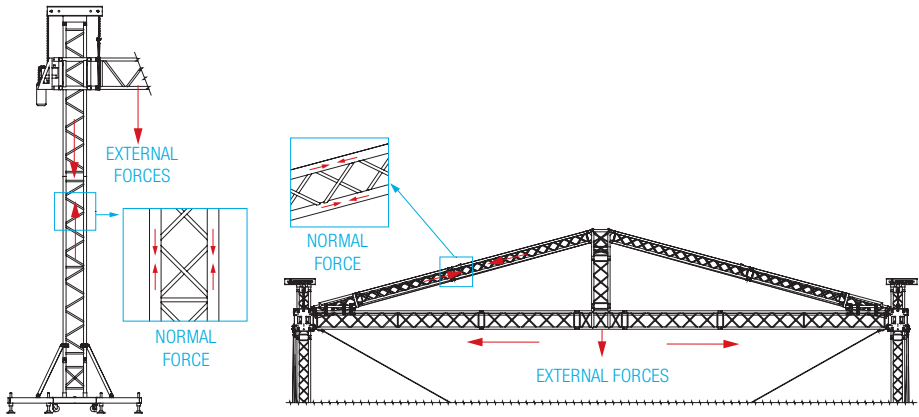

#### 3.3 BENDING MOMENT

A bending moment is the reaction induced in a truss when an external force or moment is applied to that truss causing the truss to bend. In simple words “the force which is needed to deflect a truss.”

Examples of situations where a bending moment occurs:

- Self weight caused by the force of gravity.
- Live loading such as lighting fixtures or sound equipment, curtains, drapes.
- Environmental influences like: wind force, snow loads, ice.

The bending moment acts as a compression force in the top main chord and as a tension in the bottom main chord. The braces are used to maintain the distance between the top and bottom main chords. The maximum allowable bending moment can be increased by choosing truss with a larger distance between the top and bottom main chord (e.g. larger truss). This will create a bigger distance between the forces.

The second way to increase the allowable bending moment is to increase the normal allowable force in the main chord, by increasing the diameter of the main chord or by increasing the wall thickness of the main chord.

The main chords of a truss can also be subject to a bending moment, this can be caused by mis-noding or by placing high loads between the node points.

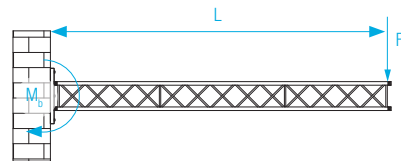

Cantilever lengths L, Force F, Bending moment  $M_b$   
Formula  $M_b = F \times L$

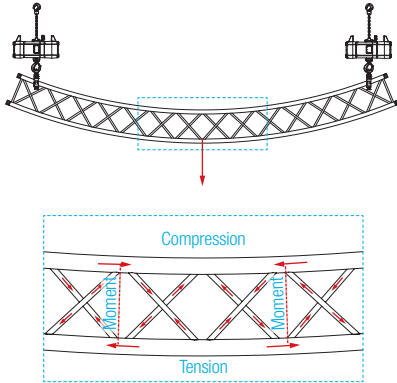
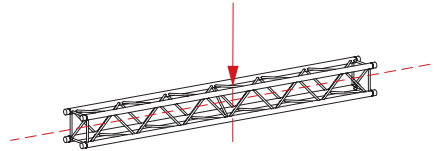

Figure: External forces cause internal forces.

### 3.4 TRANSVERSAL FORCE / SHEAR FORCE

The transversal force is the force which works perpendicular to the centre line of the truss.



Examples of situations where transversal forces are important:

- A heavy load on a short span.
- A heavy load near to the suspension point.
- Truss constructions underneath a stage floor.

The transversal force acts as a normal force in the bracing and as shear force in the main chords of a truss. The normal force in the bracing can be either compression or tension force.

The shear force on the main chord tries to “cut” the main chord. The allowable transversal force can be increased by increasing the diameter of the bracing or by increasing the wall thickness of the main chords.

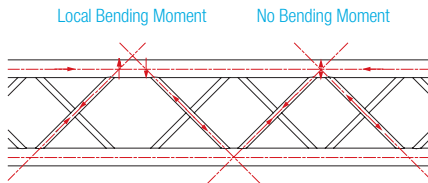

Figure: Occurrence of internal forces caused by mis-noding.

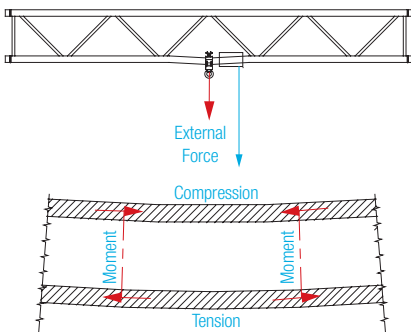

Figure: Occurrence of forces when a load or support is placed between two node points.

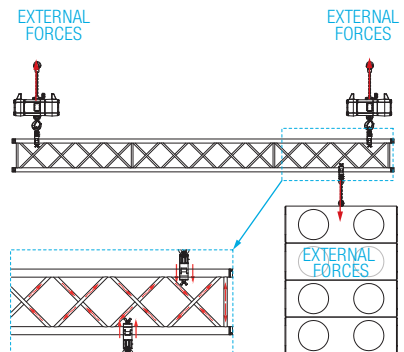

Figure: External forces lead to internal forces.

## 3. FORCES ON TRUSS

### 3.5 TORSION FORCE

This force works rotary to the centre line of the truss but is not positioned in the same plane as the centre line. This force tries to twist the truss.

Examples of situations where torsion will occur:

- Equipment on a boom arm.
- Equipment all positioned on one side (main chord) of a truss.
- Live loading on a central span in a ground support system.

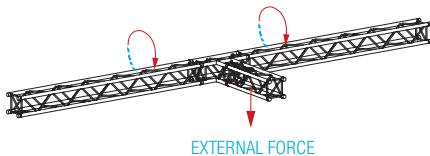

### 3.6 DEFLECTION

The deflection of a truss shows the bending forces at work. Deflection is defined as “deformation under load”.

Deflection within the allowable limits is a normal reaction and does not imply any danger regarding stability and safety. When your truss manufacturer does not supply any details on the allowable deflection limits, this can lead to a deceptive feeling of safety.

Prolyte provides two types of loading information; first, the allowable load without a deflection limit and secondly allowable load with a deflection limit of  $L/100$ . The loading tables in the catalogue contain the values without deflection limit. Loading tables which include deflection as a limiting factor are available on our website (see: TUV certificates).

Other truss manufacturers may use other deflection limits in their calculations.

However, if no details on deflection of a truss type are given, the load values should be viewed with caution. The user has no possibility to recognise the loading limit, or check excessive deflection.

Bad connections can be another cause of truss deflection. Insufficient secured bolts, worn connection elements or deformed end plates all cause extra deflection within a truss span. Prolyte's conical coupler connections (CCS®) have been designed to compensate a certain amount of wear through their tapered design. Other connection systems do not offer this possibility and hence are subject to deflection from the very beginning.

The height of a truss determines, to large extend, the stiffness of this truss. The greater the overall height of the truss section (in the direction of the load), the greater the stiffness and the smaller the deflection under the same load.

Values given by various manufacturers on the deflection of trusses differ.

This has two reasons:

1. Not all manufacturers allow for 15% greater deflection of a truss welded from aluminium in contrast to a girder made of solid material.
2. The self-weight of the truss is ignored.

Prolyte adheres to the practice of including full deflection in the technical information and giving deflection as a limiting factor for the bearing capacity. Prolyte believes it makes no sense to publish load values that do not consider deflection. The result is a feeling of insecurity for observers when they see a strongly deflected truss, even if the truss is within the limits of its bearing capacity.

### ATTENTION

- Never exceed the maximum allowable deflection of a single span (see our loading tables) without consulting a qualified structural engineer.
- Loading tables only refer to single spans, the allowable deflection on a continuous span or in 2D or 3D structure can therefore not be found in the loading tables.





Photo: PROMontaje, Venezuela, XXL Roof

There are also applications where deflection must remain within certain limits. For example, when drapes are hung from a truss span, deflection will cause the drapes to sweep the floor in the middle, while being too short on the outer ends. Or when curtain or camera tracks are used, a completely level truss is required.

Deflection of a truss is by no means simply an “optical shortcoming”; it can be of technical significance in practical applications as well. Manufacturers who do not include deflection in their data, or who do not see the bearing capacity as a limiting factor, demonstrate little understanding of the practical requirements of their customers and users.

## 4. TYPES OF LOAD

### Load can be defined as:

The sum of the forces resulting from mass, self weight or stress which a truss span is subject to. The types of load in question can be divided into two categories: uniformly distributed loads and point loads.

### Uniformly distributed loads

A load with identical weight along the whole span of a truss or a load which is distributed evenly over the nodal points of the lower chord tube of a truss is called a uniformly distributed load (UDL). Examples of uniformly distributed loads are curtains, decorations, cables and spotlights of the same weight distributed at regular intervals across the truss span.

The formula symbol for uniformly distributed load is  $Q$ , the unit is given in kg or kN.

A uniformly distributed load per metre uses the symbol  $q$  and is given in kg/m or kN/m.

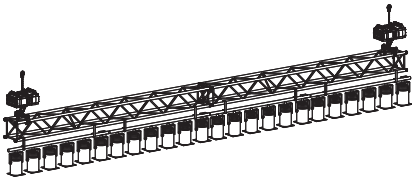

Distributed Load

### Point load

A point load describes a single load at a single point in the truss span. The most unfavourable position for a single point load is in the middle of the truss span. This type of load is called the centre point load (CPL). If this point load is placed at another point in the truss span, this results in a lower bending moment and hence smaller flexural stress, although the shear force at the active point of the force remains the same. However, the shear force increases on the support which the force is moved

towards. Examples of point loads are loudspeaker units, follow spot seats, suspension points for hanging trusses and technicians.

Prolyte regards all loads with the self weight of a person or greater as a point load and recommends all users do the same.

A technician on a truss causes a point load of at least 1kN or more as a result of dynamic loading.

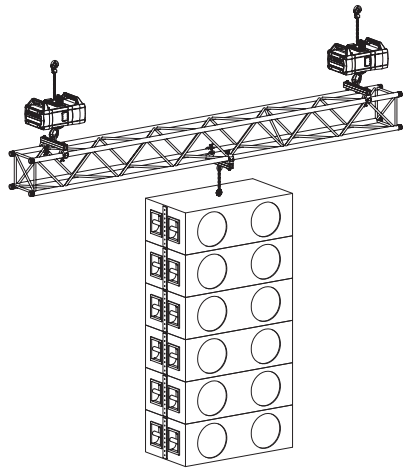

Pointload

### Several point loads

Frequently not just one single point load is found in a truss span, normally several equal point loads are found at the same regular intervals.

In our loading tables we give the allowable load caused by two equal point loads which divide the truss span into three equal sections (third point loads). Three equal point loads which divide the truss span into four equal sections are called quarter point loads, and four equal point loads

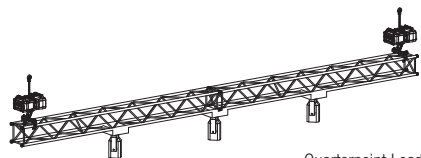

Quarterpoint Loads



which divide the span into five equal sections are called fifth point loads. For a greater number of point loads the load data for a uniformly distributed load can be used.

### Non-uniform loads

A non-uniform load occurs when only part of the span is subject to a uniformly distributed load or when several point loads are exerted in a limited zone while the rest of the span remains free of loads.

The safest way to estimate the bearing capability of a truss under non-uniform load is to determine the total load and then to consider this load as a centre point load (CPL). It is obvious that these different types of load can have extremely different effects on the stability of a truss and hence need to be dealt with separately.

Two fundamental criteria should be considered when selecting a suitable truss:

- A) The length of the allowable truss span – the distance between two supports.
- B) The allowable load of the truss for a determined truss span.

The span between two supports and the allowable load are two factors which are linked.

The bigger the span, the lower the allowable load and the bigger the load, the shorter the allowable truss span. In the few cases where the shear force and not deflection is the limiting factor, a very high load in a very short truss span can cause failure in the support zone.

This will result in buckling of the chord tubes, buckling of the diagonals under load, or in a rupture of the welding seams in braces under load. Each truss type, independent of the manufacturer, has its specific failure criteria. It is the responsibility of each manufacturer to ensure that these criteria never represent a lasting danger when calculating the allowable loads and spans.

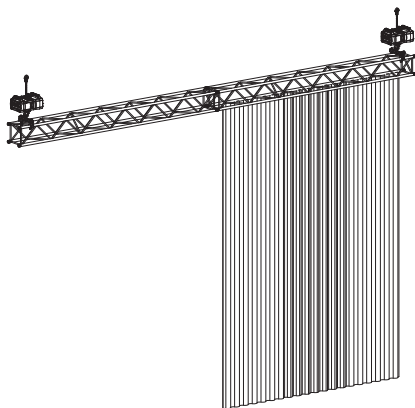

Partial distributed load

## 5. SPECIFIC LOAD SCENARIOS

### 5.1 FOR USE OUTDOORS OR IN ENCLOSED SPACES

The difference regarding loading whether trusses are used outdoors or in enclosed spaces is as important as it is apparent: climatic conditions have a great influence on the safety of the construction.

#### Wind:

- Can cause horizontal loads on a truss section.
- Can cause the construction to tilt, lift off the ground or slide.
- Can cause overload on the trusses which have to absorb forces transmitted via drapes or other surfaces exposed to wind.
- Can damage the roof, side and rear covers.

#### Rain and snow:

- Can cause overload if water masses build up.
- Loads caused by the weight of snow must be avoided.
- Can soften up the ground and hence lessen its bearing capability.
- Increases the risk of slipping when climbing along a truss.
- Can affect the electric equipment.

#### Lightning:

- Can endanger persons and electric installations.

#### Temperature:

- Towers and trusses can heat up considerably in strong sunshine. This can be hazardous when climbing, in particular if additional heat is generated by lighting equipment. Appropriate protective clothing must be worn and textile lifting accessories must be protected against the effects of heat.

### 5.2 HORIZONTAL LOADS

Horizontal loads are often underestimated.

They are caused by many factors, e.g. wind, tension forces created by canopies, drapes, screens, etc. The values given in the loading tables refer to loading of the truss in a vertical direction. If a second bending force in horizontal direction is added, this can cause overloading of the truss even though the vertical load is within the limits of the table. Due to their design the truss types S36R, S52F & V, S66R & V and S100F may not be subjected to any horizontal loads without consulting a structural engineer. If this cannot be avoided, these forces must be transferred, e.g. via other trusses for transferring compression forces or steel wires for transferring tension forces.

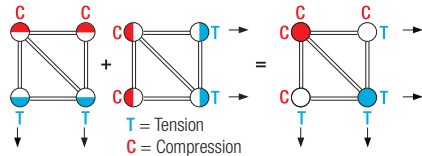

### 5.3 DYNAMIC FORCES

When hoisting and lowering loads, the starting and stopping cause additional dynamic forces which must be taken into consideration when determining the overall load. When using standard hoist often with 4/8 m/min normally a factor of 1.2 to 1.4 is used to determine the dynamic loads. If higher speeds are expected, e.g. very fast running chain hoists and winches or artistic performances, the loads and bearing capability should be calculated by a competent person.



Photo: Astana, Asian Winter Games

#### 5.4 THEORY AND PRACTICE

Although all our calculations and theoretical models reflect state-of-the-art technology, it is not possible to cover all situations in daily life. For us as a manufacturer, feedback on such situations is an important source of information which helps us to provide satisfactory solutions and long-term quality ratings for our products. In our Engineering and Sales Departments we employ experts with practical experience in the areas of rigging and trusses. Their invaluable knowledge, together with the knowledge which we have gathered over many years as a professional manufacturer of Prolyte, represents an enormous advantage which we would like to share with our users.

Awareness of possible gaps in our theoretical knowledge about trusses and their applications reminds us of our responsibility to help our users by sharing knowledge. This way we can help to ensure safe working conditions and high durability of our products.

## 6. TRUSSES AND LOADS

### 6.1 SPAN ON TWO SUPPORTS

The simplest version of a span is a span on two supports, known as a single span. The loading tables give the load values for a single span. This is the most common type of truss application in events technology. The truss is supported at both ends and hence allows for vertical deflection of the truss under load between these supports.

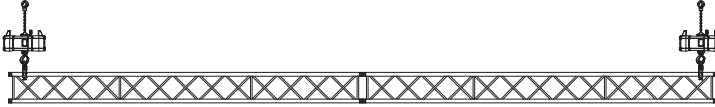

### 6.2 RIGID RESTRAINT (FIXED SPAN)

Load values which refer to bilaterally mounted spans are difficult to produce since this type of application is very unusual in event technology. Manufacturers who publish such load values appear to be interested in demonstrating high bearing capabilities which, however, are viable in very few cases.

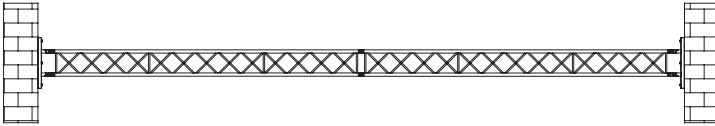

### 6.3 CANTILEVER SPAN

Spans with projections are single span spans with the supports placed inwards so that the end of the truss projects over the supports. The total load on the truss and its self weight influence the shear force in the zone of the supports. The larger the cantilever, the greater the bending moment at the point of support. Furthermore, cantilevers are only protected against torsion forces by the support they cantilever over and therefore are very susceptible to non-uniform loads.

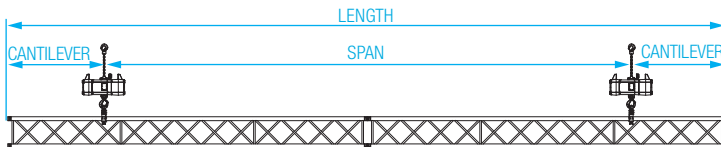

If truss spans are limited, the trusses can be extended beyond the supports in the case of single span spans. As a rule of thumb, as shown in the diagram, one sixth of the span can be assumed as an allowable cantilever, that can be loaded to the same amount of load as in the main span.

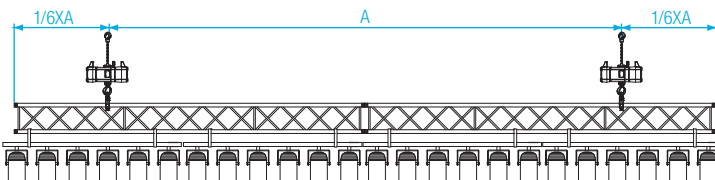



## 6.4 CONTINUOUS SPAN

Continuous spans on more than two supports are described as statically undetermined systems. The load in one span – the area between two supports – influences the behaviour of the span in the neighbouring areas.

The potential load scenarios are practically endless. The possible consequences for the allowable load are so complex that it is impossible to publish a specific loading table for the numerous load combinations.

However, information about the support reaction in multiple supported spans is very important, because the shear force at all support points must remain within the allowable range for the truss and for the support point.

Furthermore the property of the bending moment over the inner supports is the reverse to that in the middle of the span. In the middle of the span the bending moment causes tension in the lower chords and compression in the upper chords. Over the middle supports the bending force causes tension in the upper chords and compression in the lower chords.

In this respect Prolyte complies with the requirements of German Industrial Norms (DIN) as well as the latest developments in ESTA-ANSI (USA), PLASA-BSI (UK), NEN (NL), VPLT (D) and CEN (EU) drafts on the design, manufacture and application of trusses in event technology.

## 6.5 LOADING OF TRUSS CORNERS

The exact determination of the allowable loading of corner elements is a complicated matter.

The design and construction of a corner element will influence the allowable load on that element. Not all corner elements can absorb the load applied by the connected truss sections when these are under a maximum load. Many manufacturers do not take this into consideration when referring to their load values. Furthermore, not only the construction is decisive for the allowable load on a corner element, but also its position in a 2D or 3D truss construction. Therefore the load on corner elements must be checked for each individual case, including the lengths and loads on the adjoining truss sections.

Over the last two years Prolyte has improved its welded corner elements or redesigned them in order to increase the allowable capacity.

As a rule of thumb it can be assumed that truss sections adjoining welded Prolyte corner elements may be loaded with around 50% - 100% of their allowable load.

If we look at the loading tables for the allowable central point load of the shortest span, for example 4 m X30D = 451.3 kg, only 50 % of this value, that is 225.7 kg, should be assumed. The supports with the highest percentage should never be subjected to a higher load than this. Hence we can calculate a maximum allowable uniformly distributed load for a construction using X30D trusses of c. 1026 kg. This means support loads of:

140,6 kg	225,7 kg	140,6 kg
140,6 kg	225,7 kg	140,6 kg

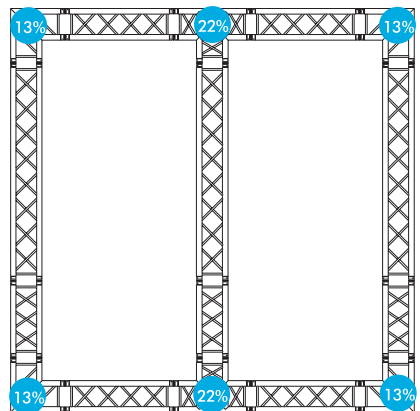

Assuming that each truss node represents a support, the approximate support reactions are given here as a percentage of the total uniformly distributed load of a square construction with a central truss.

## 6. TRUSSES AND LOADS

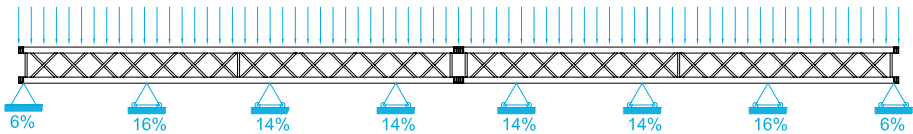
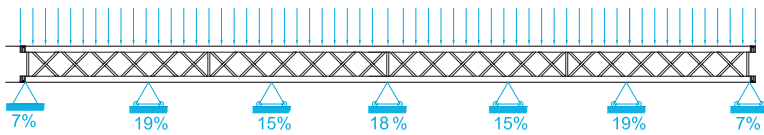
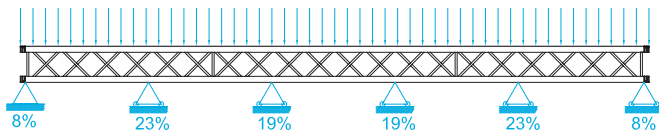
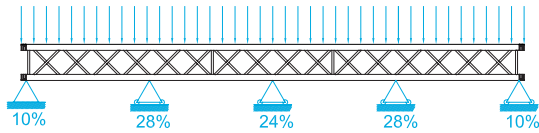
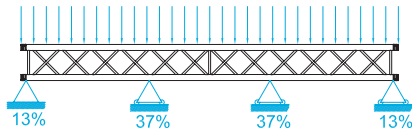
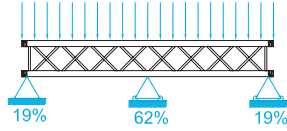
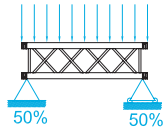





Assuming that each truss node represents a support, the approximate support reactions are given here as a percentage of the total uniformly distributed load of a square construction with a truss cross in the centre.

If we look at the loading tables for the allowable central point load of the shortest span, for example 4 m X30D = 451.3 kg, only 50 % of this value, that is 225.7 kg, should be assumed in order to determine the allowable load of the C-016 node. The support with the highest percentage should never be subjected to a higher load than this. Hence we can calculate a maximum allowable uniformly

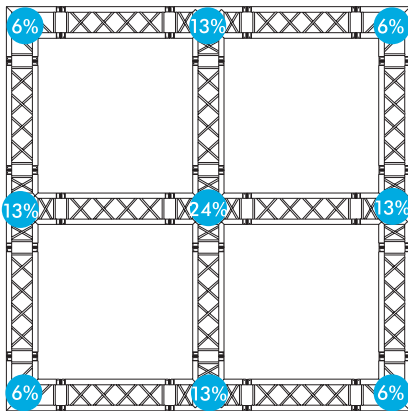

distributed load for a construction with X30D trusses of c. 1026 kg. This means support loads of:

56 kg	122 kg	56 kg
122 kg	225,7 kg	122 kg
56 kg	122 kg	56 kg

Here it should be emphasised that almost one quarter of the uniformly distributed total load is concentrated in the central cross section module.

## 6.6 CIRCULAR TRUSS BASIC TECHNICAL INFORMATION

Prolyte is known for its full range of truss series for the widest range of applications. In addition, Prolyte manufactures trusses in circular form, arcs and ellipses. Prolyte manufactures these curved trusses with an especially high level of precision to ensure good fitting accuracy without distortion. All circular trusses are manufactured in a specialised department within the company. This department is equipped with state-of-the-art welding jigs that are designed in-house. This welding jigs allow all circular segments to be manufactured as standard elements, from the decorative E20 truss to the robust S66 series. This ensures that each curved segment can be inserted at any position in a circle without impacting the overall shape of the circle.

Circular trusses and arcs can be made with any truss series, except for S52F and S100F.

### Circular truss production

Although Prolyte has raised the production of circular trusses to the same standard as straight trusses, the two are always differentiated. The production of curved trusses requires considerably more time. Each individual chord tube has to be rolled to the specific radius it needs in order to function as a chord tube of a circular truss. This means that a curved truss has at least two different chord tube radii: the inner and the outer radius. Each tube can only be rolled over a limited length by the rollers of the bending machine. The loss during bending is ca. 20-25 cm at each tube end. This means that a semi-finished product length of 6 m has a curved length of around 5.5 m. This is the segment length for curved trusses that form a circle. A further factor that affects circle and arc production is the position of the diagonals. This is defined exactly by the welding equipment when producing straight trusses. However, for circular production no practicable solution exists.

## 6. TRUSSES AND LOADS

There is a lower limit for the bending radius for each type of tube. If the radius is made smaller, the chord tube assumes an oval shape (10% deformation is the maximum limit) and it loses its shiny surface due to the strong compressive forces on the inner edge. The degree to which a tube can be rolled with satisfactory results depends on 3 factors:

- outer diameter of the tube; this has a direct influence on the geometrical moment of inertia and the resistance to bending.
- wall thickness of the tube; this also has a direct influence on the geometrical moment of inertia and the resistance to bending, with thicker walls being less susceptible to surface changes but requiring considerably more time and energy to bend.
- composition of the tube; the lower the rigidity, the easier the cold forming process is.

Polyte gives the values of the circular truss dimensions as the outer radius of the outer chord tube. The inner radius of the inner chord tube limits the bending process. The values given are minimum circle dimensions which ensure that the tube surface and the stability do not deteriorate greatly.

E -Serie (32 x 1,5 mm)	Minimum tube bending radius 400 mm Minimum circle diameter 1,3 m
X -Serie (51 x 2 mm)	Minimum tube bending radius 1.000 mm
X30 -Serie	Minimum circle diameter 2,2 m
X40 -Serie	Minimum circle diameter 2,4 m
H -Serie (48 x 3 mm)	Minimum tube bending radius 800 mm
H30 -Serie	Minimum circle diameter 2,2 m
H40 -Serie	Minimum circle diameter 2,4 m
S -Serie (50 x 4 mm)	Minimum tube bending radius 1.300 mm
S36R	Minimum circle diameter 3,2 m
S36V	Minimum circle diameter 3,4 m
S52V	Minimum circle diameter 3,7 m
S66R	Minimum circle diameter 3,6 m
S66V	Minimum circle diameter 4,2 m

### How to select a circular truss

For applications in event technology we always recommend a division into 4, 8, 12, 16...segments. With this division circles can be used in different constructions as shown in the following figures. The number of segments of a circle depends on the radius of the circle.

The maximum tube length that can be bent is 5.5 m, which means that circular segments cannot be longer. Average lengths between 2 m and 4 m are the easiest to handle, transport and store. We recommend that our customers adhere to these values when ordering a circle. Furthermore, for three-chord circular trusses the position of the triangle – point up/down, outside or inside – should not be forgotten.

### Loads on circular trusses

Circular trusses in a horizontal position – and to an extent also arc segments – can absorb less load than straight trusses.

In an arched segment the braces in the vertical plane for the inner and outer side are fundamentally different. Hence the effective length of the braces is always greater on the outside than on the inside. This means that an asymmetrical distribution of force is built into the truss.

The result is not only a different load on the chord tube, diagonals and connection elements through bending and shear forces, but also a rotation and torsion force which affects the bearing capacity of the truss.



The torsion force influences the danger of buckling in the arched spans. These effects have a great influence on the different types of circular truss, depending on whether they have two, three or four chord tubes. The minimum number of supports for circular trusses and diagonals on all sides used in a horizontal position without causing problems of stability or balance is “three”.

Circular trusses with only two supports are principally unstable and therefore considered unsafe.

If a circular truss is tilted from a horizontal position or is moved during an event, it is extremely difficult to calculate the allowable load because it is not possible to predict the resulting load for every possible angle of tilt.

In such cases we urgently recommend to enlist the aid of a structural engineer.

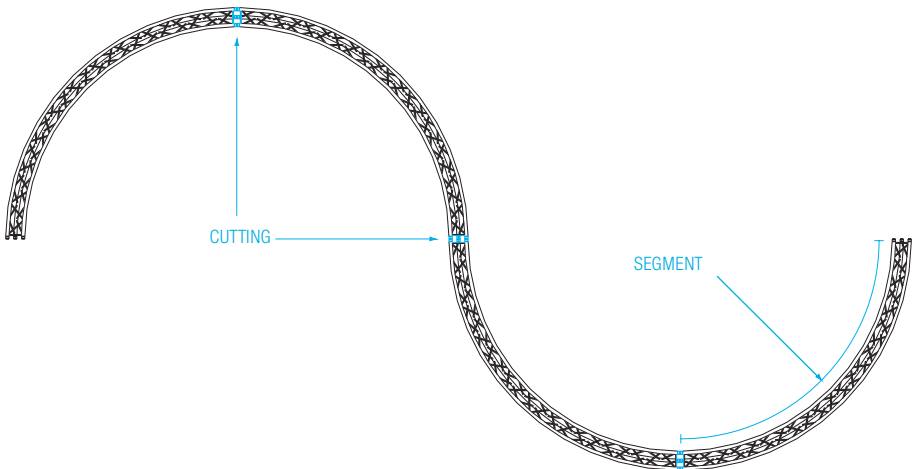
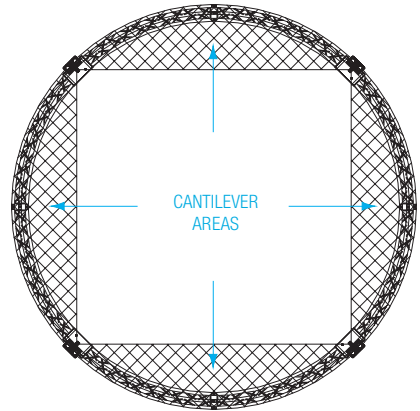

## 6. TRUSSES AND LOADS

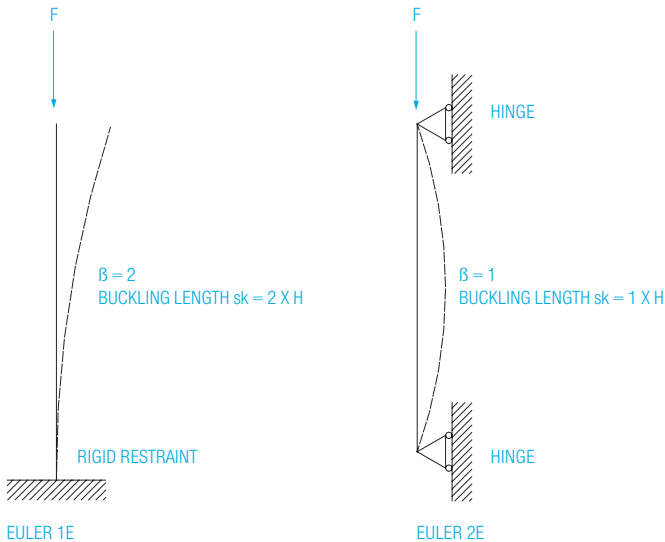

### 6.7 LOADING OF VERTICAL TRUSSES (TOWERS)

Our technical department is frequently asked for loading tables for trusses used as towers. In such applications buckling can easily lead to failure before reaching the allowable compression forces (normal forces). A truss tower under compression tends to deflect laterally (sideways). Relevant factors in this type of use are:

- The height of the tower.
- The cross section of the tower.
- Restraint of the tower at both ends (top/bottom).

The theory of determining the maximal axial load that a long slender (ideal) column can resist without buckling is based on the Eulerian buckling modes, derived by the swiss mathematician Leonhard Euler in the mid 18th century.

The Eulerian buckling theory is relevant in the following use of tower truss:

- 1: Fixed at the bottom, free at the top.  
(This is similar to a cantilever situation).
- 2: Pinned (or hinged) on both sides (tower or leg in a ground support construction).

Please keep in mind that many other factors are relevant when calculating the risk of buckling of a truss! It is not possible to give the allowable load values when only the height and the type of truss of the tower is known, therefore a simple table that pays respect to all relevant factors is impossible. The examples given in the following section are all theoretical and only explain how different systems affect the allowable loading.

Specific calculations for the individual system (truss construction) are required in these cases. We strongly recommend that these calculations shall be carried out by a qualified engineer. All examples are based on the assumption that the towers are supported symmetrically in two opposite rectangular directions (e.g. when guywires are used on one side, they should be applied on the other side as well).

Please keep in mind that the Euler Modes are theoretical models, a truss differs from an ideal column and the fixations provided by truss corners, sleeve blocks, base-sections or baseplates do not provide a 100% restraint. Structural engineers extend the values of the buckling factor  $\beta$  in order



## Example 1

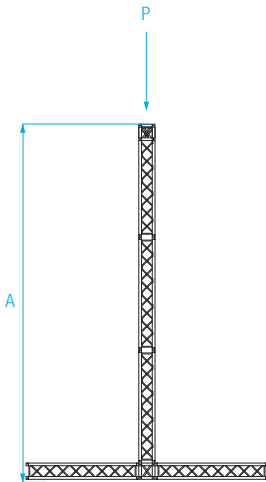

to match the given situation. The buckling length  $s_k$  of a tower is calculated by multiplying the buckling factor  $\beta$  by the tower height  $A$ .

### Example 1 – Single tower (cantilever column)

Free-standing tower with fixation through base section or trusses connected to the bottom end and free (not fixed) at the top. This example refers to Euler buckling mode 1.

Assumption: Only vertical loading (no horizontal loading through wind forces etc. -> indoor use only).  
Buckling length  $\beta = 2-3 \times$  tower height.

### Single Tower

Truss: H30V

Tower height  $A$ : 6,0m

Assumed factor  $\beta$  to determine the buckling length:  $\beta = 2,5$

Buckling length  $s_k = 2,5 \times 6m = 15m$

Following the design principles of Eurocode 9, Chapter 6, we find formulas which result in an allowable loading of  $P = 18,65kN$ .

### Example 2

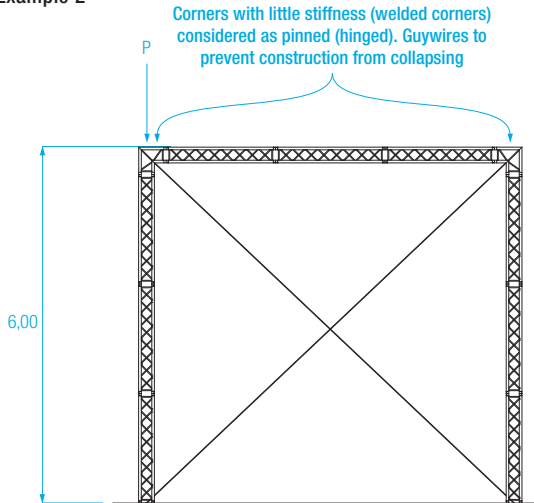

#### Example 2 - Pin-ended column

Towers with hinged connections at the bottom and top end, like tower-bases at the bottom and sleeve blocks at the top end in combination with cross guywires. This example refers to Euler buckling mode 2.

Assumption: Only vertical loading on towers (no vertical load on horizontal truss and no horizontal loading through wind forces etc. -> indoor use only).

Buckling length  $\beta = 1 \times$  tower height.

#### Pin-ended column

Truss: H30V

Tower height A: 6,0m

Factor  $\beta$  to determine the buckling length:  $\beta = 1$

Buckling length  $sk = 1 \times 6\text{m} = 6\text{m}$

Following the design principles of Eurocode 9, Chapter 6, we find formulas which result in an allowable loading of  $P = 85,3\text{kN}$ .



### Example 3

Corners with strong stiffness considered as partly restraint

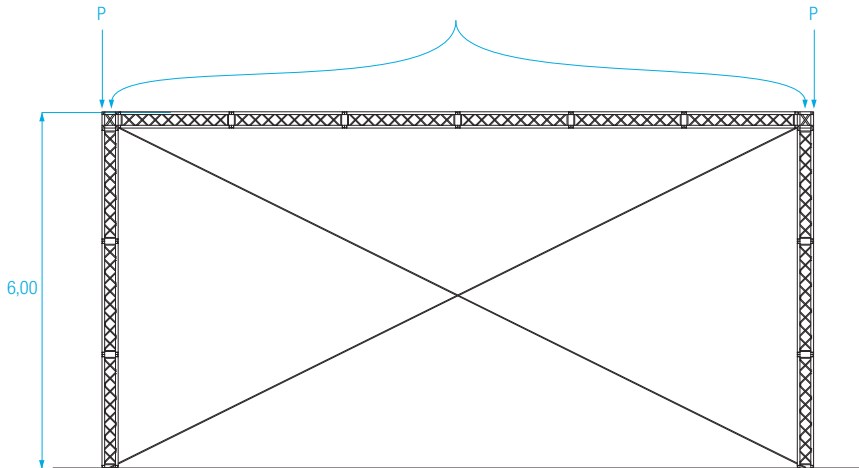

### Example 3 - Frame column

Towers have hinged connections at the bottom and partly restrained connections at the top end, like baseplates at the bottom and boxcorners at the top end. This example refers to Euler buckling mode 1. Only vertical loading on towers (no vertical load on horizontal truss and no horizontal loading through wind forces etc. -> indoor use only).

Buckling length  $\beta = 2,0-3,5$  x tower height

### Frame column

Truss: H30V,

Tower height A: 6,0m

Grid width 12m.

The buckling factor is determined by the stiffness of the connection between the vertical and horizontal truss (tower and grid). The stiffness is also dependent on the width of the frame.

A smaller grid gives a higher stiffness to the corners and therefore a smaller buckling length of the towers. In this case the assumed buckling factor is  $\beta = 3$ . Buckling length

$sk = 3 \times 6m = 18m$

Following the design principles of Eurocode 9, Chapter 6, we find formulas which result in an allowable loading of  $P = 13,0kN$ .

### Conclusion

A tower build from H30V with a height of 6m gives three totally different outcomes in the allowable loading depending on the system it is part of. Please keep in mind that the examples are theoretical. In daily practice there will be load on the horizontal trusses, which results in bending forces on the towers, depending on the stiffness of the corners. Moreover you will have to consider horizontal loads on the whole structure.

Polyte recommends that calculations of tower loading shall be carried out by a qualified engineer.



Photo: Prolyte Group, Leek, The Netherlands

### 7.1 STANDARDS AND REGULATIONS

Prolyte trusses are calculated according to the European standards for structures. These standards are known as Eurocodes. In detail these are EN 1990 “Basis of structural design” (Eurocode 0), EN 1991 “Actions on structures” (Eurocode 1) and EN 1999 “Design of aluminium structures” (Eurocode 9).

Outside the European Union other standards might be applicable, however since Prolyte is an European company we apply to European standards. Prolyte trusses can be calculated according to other standards on demand.

Structures or constructions made from Prolyte truss can be subject to additional European or national standards like EN 13814 - Fairground and amusement park machinery and structures – Safety, or the British code of practice “Temporary demountable structures” endorsed by the British HSE.

Sometimes, additional regulations need to be taken into account in the use of truss – this can be applicable in quite common situations, like rigging your truss in a venue.

When truss is used as lifting device it is to be considered as ‘work equipment’ in the definition of the European regulation Directive 2009/104/EC – use of work equipment. When truss is used as structural component it is to be considered as a ‘construction product’ in the definition of the European regulation Directive 2006/42/EC – the so-called Machinery Directive.

Furthermore national regulations and like those published by health and safety organisations have to be respected. Like the British “LOLER - Lifting Operations and Lifting Equipment Regulations” or the German “DGUV V17 – Staging and Production Facilities for the Entertainment Industry”. None of these applicable directives, regulations and rules determine calculation principles for the design of trusses, but define precautions and factors of safety when using trusses.

There might be many other regulations in the world, always be aware of applicable laws, regulations and rules when using Prolyte products.

All the above given standards and regulations have to be respected but none of them refers directly to the design of trusses for the entertainment industry.





Therefore a bunch of committed entertainment professionals gathered under the roof of the European Committee for Standardization (CEN). This committee created CEN Workshop Agreement (CWA 15902 - Lifting and Load-bearing Equipment for Stages and other Production Areas within the Entertainment Industry - Part 2: Specifications for design, manufacture and for use of aluminium and steel trusses and towers) in 2008. It is to be expected that this document will become an European standard under the wings of CEN TC 433 "Entertainment Technology - Machinery, equipment and installations" in the near future.

## 7.2 MATERIAL SPECIFICATION

The most common used alloy for the manufacturing of trusses is EN-AW 6082 T6. Other, less rigid, alloys are used in individual cases. The decorative trusses Prolyte manufactures are made from EN AW 6060 T66. The EN- is a so-called hardened alloy. The technological specifications of hardened alloy are modified by the action of heat. The application of heat during welding reduces the tensile strength of the basic material in a certain zone around the weld. This zone is called the heat affected zone (HAZ). The size of the HAZ and the remaining residual strength as well as workpiece geometry and many other parameters are also determined by the welding process itself (e.g. MIG and WIG).

## 7.3 MATERIAL SPECIFICATION

EN AW6082 T6 is the most commonly used alloy for manufacturing trusses.

Other less rigid alloys are used in individual cases. As is the case for all aluminium alloys that are hardened, the technological specifications of a specific alloy are modified by the action of heat. The application of heat during welding reduces the tensile strength of the basic material in a certain zone around the weld.

This zone is called the heat affected zone (HAZ). The size of the HAZ and the remaining residual strength as well as workpiece geometry and many other parameters are also determined by the welding process itself (e.g. MIG and WIG). The corresponding DIN standards do not differentiate between the various welding processes in relation to calculation of the bearing

capacity. Other standards include this differentiation, although this is not yet generally accepted.

## 7.4 DIAGONAL BRACES

Aluminium is a very flexible material because of its low coefficient of elasticity. Therefore, in the calculation process, the diagonal braces are assumed to be mounted flexibly on both sides. If they were assumed to be fixed on both sides, this would reduce the buckling length. Modern engineering methods prescribe that, for spatial structures where the main chord has a decisive larger diameter than the diagonals, a situation occurs where the restraint is a combination of both and therefore a reduction factor for the buckling length applies.

As shown in the picture below, the diameter of the braces provide a larger circumference at the intersection ( $d_2$ ) of the chord tube and the brace. Hence this is a larger circumference for the welding seam compared with the circumference of the brace ( $d_1$ ). This difference means the welding seam can be taken to around 9/10 of the circumference without reducing the overall bearing capacity of the connection.

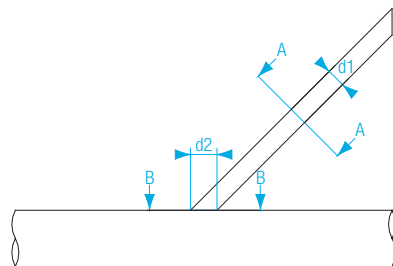

Section A-A --- Circumference =  $\pi \cdot d_1$

Section B-B --- Circumference =  $\pi \cdot d_2$

$d_1 < d_2$

result : surface A-A < Circumference Section B-B

## 8. TRUSS APPLICATION AND RELATED SAFETY FACTORS

As described in Chapter 7, Prolyte truss is calculated according to Eurocode. Since the Eurocodes are standards for the structural design of constructions like buildings or civil engineering constructive works, the basic safety factors of Prolyte truss is the same as for aluminium structures. Aluminum trusses can be used in different applications where they are covered by different regulations or additional standards.

### 8.1 TRUSS USED AS CONSTRUCTION PRODUCT

When truss is used to build outdoor structures, it has to be considered as a construction product. In Europe construction products are covered by Regulation (EU) 305/2011, the so called Construction Products Regulation (CPR). When the construction product complies to a harmonized European standard for construction products or parts of it. The CPR demands a construction product made from aluminium to EN 1090 "Execution of steel structures and aluminium structures" and thereby also to EN 1999 "Design of aluminium structures" (Eurocode 9). Therefore the safety factors for Prolyte trusses derive from Eurocode 9.

In very special applications, where trusses are used in structures covered by EN 13814 "Fairground and amusement park machinery and structures" the safety factors might be a little lower than defined by Eurocode 9. Prolyte advises not to accept any given safety factor lower than those defined in Eurocode 9.

### 8.2 TRUSS USED AS LOAD BEARING ELEMENT

If a truss is used to carry loads (e.g. lighting or sound equipment) and is lifted by hoisting devices, e.g. chain hoists, the truss can be regarded as a lifting accessory, as such, the truss is subject to the machinery directive (DIRECTIVE 2006/42/EC).

The machinery directive demands a safety factor for lifting accessories of 1.5 against plastic deformation. This is slightly lower than the demands of Eurocode 9. As soon as the lifting accessory is used to carry people, the machinery directive demands a doubling of the safety factors!

Since moving or carrying people by means of lifting accessories is considered to be at the same level

of risk as moving loads above people, it is common practise to double the safety factors when moving or suspending trusses above people for trusses that are not certified by a notified body.

Prolyte follows the highest levels of safety and complies to all applicable regulations. The loading figures of Prolyte trusses are certified by a German notified body. Therefore it is not needed to double the safety factor of certified Prolyte trusses as a general rule.

### 8.3 ADDITIONAL SAFETY FACTORS FOR TRUSSES

All Prolyte truss is calculated by qualified and experienced engineers. The basic results of these calculations are the loading tables. The loading tables are only valid for truss used as single span beams. The values given in these loading tables can be used without additional safety factors.

Prolyte has a very open policy toward sharing its calculation factors, to further enhance customer convenience. Therefore Prolyte publishes the design internal forces of all trusses according to the Load Resistance Factor Design of the Eurocodes. These design internal forces of the trusses, Normalforce (NR,d), Bendingmoment (MR,d) and Shearforce (VR,d) need to be multiplied by a safety factor of at least 1,5 if used for individual load calculation.

Users are often unsure or confused about the demand for using higher safety factors (8, 10 or 12) in the entertainment industry. These higher safety factors are relevant for slings, steelwires and chains used as lifting accessories but NOT for trusses!

The British standard BS 7905/7906, the CWA 15902-1&2 and the American standard ANSI E1.2-2000 prescribe multiplying the values in the loading tables with the factor 0.85 to compensate for wear and tear.

Unfortunately these standards do not regulate when trusses should be discarded. Such data shall be provided by manufacturers as a safety measure for working with trusses.

Prolyte provides all criteria for maintenance and rejection of trusses for your safety.



Apart from that, Prolyte offers inspection service for truss elements.

The German standard IGWW SQP1 states that the truss manufacturer is not responsible for the wear of the truss. However, clear guidelines are not available for this area, and according to European regulations the responsibility should lie with the owner/user of the truss. Prolyte recommends to keep a log of your truss usage.

If national or regional regulations, guidelines or laws place higher demands on technical equipment, these should always be followed.

All users/technicians have the responsibility to remain up to date with the applicable regulations, guidelines, laws and standards.



## ATTENTION

It is not allowed to exceed the allowable loading for truss.

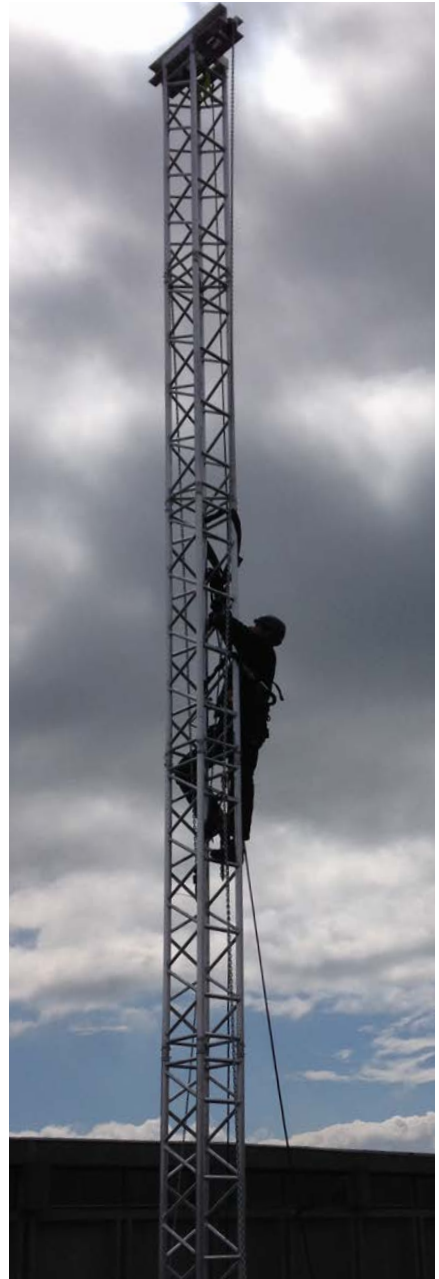

Photo: ETP, Copenhagen, LT Roof

## 9. LOADING TABLES

The load values apply for a single span without cantilevers when subject to a UDL (uniformly distributed load), a CPL (centre point load) or several equal point loads at regular distances

from each other and to the supports. The loading tables apply for spans which are composed of any lengths of truss types.

- 
- 1 Length of the truss span in metres.
  - 2 Length of the truss span in feet.
  - 3 Allowable uniformly distributed load (UDL) in kg/m.
  - 4 Allowable uniformly distributed load (UDL) in lbs/ft.
  - 5 Deflection in millimetres under UDL.
  - 6 Deflection in inches under UDL.
  - 7 Allowable centre point load in kg (a point load that divides the span in 2 equal sections).
  - 8 Allowable centre point load in lbs (a point load that divides the span in 2 equal sections).
  - 9 Deflection in millimetres under CPL.
  - 10 Deflection in inches under CPL.
  - 11 Allowable third point loads (TPL) in kg (two equal point loads that divide the span in 3 equal sections).
  - 12 Allowable third point loads (TPL) in lbs (two equal point loads that divide the span in 3 equal sections).
  - 13 Allowable quarter point loads (QPL) in kg (three equal point loads that divide the span in 4 equal sections).
  - 14 Allowable quarter point loads (QPL) in lbs (three equal point loads that divide the span in 4 equal sections).
  - 15 Allowable fifth point loads (FPL) in kg (four equal point loads that divide the span in 5 equal sections).
  - 16 Allowable fifth point loads (FPL) in lbs (four equal point loads that divide the span in 5 equal sections).

## R30V - Allowable Loading

SPAN		UDL		DEFLECTION		CPL		DEFLECTION		TPL		OPL		FPL		SPAN	
m	ft	kg/m	lbs/ft	mm	inch	kg/s	lbs	mm	inch	kg/s	lbs	kg/s	lbs	kg/s	lbs	kg/s	total weight
3	9.8	64.90	436.7	10	0.4	1667.9	3681.0	8	0.3	973.4	2148.4	649.0	1432.2	486.7	1074.2	18.9	
4	13.1	485.3	326.5	18	0.7	1298.1	2864.9	15	0.6	932.1	2057.2	647.1	1428.1	485.3	1071.1	25.2	
5	16.4	387.1	260.5	28	1.1	1074.2	2370.9	23	0.9	749.1	1653.3	581.1	1282.5	469.0	1035.1	31.5	
6	19.7	321.6	216.4	41	1.6	914.4	2018.2	33	1.3	644.7	1422.8	488.7	1078.6	389.3	869.3	37.8	
8	26.2	194.4	130.8	73	2.9	700.6	1546.3	45	1.8	564.8	1246.5	420.7	928.6	337.3	744.4	44.1	
9	29.5	152.4	102.5	92	3.6	625.2	1379.9	74	2.9	450.2	993.7	327.0	721.8	264.5	583.8	56.7	
10	32.8	122.3	82.3	114	4.5	563.2	1242.9	91	3.6	407.6	899.5	293.2	647.1	238.0	525.2	63.0	
11	36.1	100.1	67.4	137	5.4	511.0	1127.8	110	4.3	371.5	820.0	265.1	586.0	215.7	476.1	69.3	
12	39.4	80.2	53.9	164	6.4	466.3	1025.0	131	5.2	336.8	737.7	241.2	536.3	196.8	437.9	75.6	
13	42.6	70.1	47.2	192	7.6	428.0	944.6	154	6.1	313.7	692.4	220.7	487.0	180.5	398.3	81.9	
14	45.9	59.6	40.1	223	8.8	394.3	870.2	178	7.0	290.1	640.2	202.8	447.5	166.2	366.8	88.2	
15	49.2	51.2	34.5	256	10.1	364.5	804.3	205	8.1	269.1	593.8	177.0	412.8	153.6	338.9	94.5	
16	52.5	44.3	29.8	291	11.5	337.8	745.5	233	9.2	250.3	552.3	163.0	381.9	142.3	314.1	100.8	
17	55.8	38.6	26.0	328	12.9	313.8	692.5	263	10.4	233.3	514.9	160.4	354.1	132.2	291.8	107.1	
18	59.0	33.8	22.8	368	14.5	292.0	644.5	295	11.6	217.9	480.8	149.1	329.0	123.1	271.6	113.4	
19	62.3	29.8	20.0	410	16.1	272.2	600.7	328	12.9	203.7	449.6	138.7	306.2	114.7	253.2	119.7	
20	65.6	26.3	17.7	454	17.9	253.9	560.4	364	14.3	190.7	420.9	129.3	285.3	107.1	236.3	126	

1 inch = 25.4 mm | 1 m = 3.28 ft | 1 lb = 0.4535 kg

- Tuv certification only valid for loading table above.
- Loading figures are only valid for static loads.
- Loading figures are only valid for single spans with supports at both ends.
- All static systems, other than single spans, need an individual structural calculation. Please contact a structural engineer or ProLite Group for assistance.
- Loading figures are calculated according to and in full compliance with European standards (Eurocode).
- The self-weight of the trusses is already taken into account.
- Loading figures are only valid for the cross sectional orientation of the truss as shown by the icon in the loading table.
- The interaction between bending moment and shear force at the connection point is already taken into account.
- Truss spans can be assembled from different truss lengths.
- Read the manual before assembling, using and loading the truss.





Photo: Eurovision Song Contest 2014, picture by Ralph Larmann



### 10.1 RULES FOR TRUSSES AND STRUCTURES

Design and manufacturing of trusses made from aluminium is subject to the following standards and regulations:

#### Manufacturing

- EN 573 - Aluminium and aluminium alloys, designation and chemical composition.
- EN 755 - Aluminium and aluminium alloys. Extruded rod/bar, tube and profiles. Mechanical properties: physical properties such as tensile strength and hardening properties.
- EN ISO 18273 - Welding consumables. Wire electrodes, wires and rods for welding of aluminium and aluminium alloys. Classification.
- EN ISO 14175 - Welding consumables -- Gases and gas mixtures for fusion welding and allied processes.
- Qualification of arc welding procedure according to EN ISO 15613 or EN ISO 15614-2.
- Quality requirements for welding according to EN ISO 3834-2.
- Welding procedures specifications according to EN ISO 15609-1.
- Qualification of welders – Fusion weld according to ISO 9606-2.
- Welding coordinator qualified according to EN ISO 14731.
- ISO 9001 Quality Management.
- EN 1090-1:2009 + A1:2011 Execution of steel structures and aluminium structures. Requirements for conformity assessment of structural components.

#### Structural calculation

- Aluminium structures EN 1990 (EUROCODE 0), EN 1991 (EUROCODE 1), EN 1993 (EUROCODE 3) and EN 1999 (EUROCODE 0).
- EN 13814 Fairground and amusement park machinery and structures. Safety.

Prolyte manufactures aluminium trusses for the entertainment industry according to the following aspects:

#### Materials

The materials processed by Prolyte are subject to a rigorous quality assurance by the suppliers. In particular, aluminium materials are alike in appearance, but may have serious quality differences. Users should always ask what kind of materials were used by a manufacturer. Good product information documents should contain this information. Prolyte uses aluminium tubes made of the aluminium alloy EN AW 6082 T6. All materials used by Prolyte have an inspection documents 3.1 in accordance with EN 10204. This certificate confirms that the chemical composition and mechanical properties lie within the prescribed tolerances.

#### Welding procedure

It is not easy to judge a welding seam by its appearance. Prolyte guarantees that the welding is performed in strict compliance with the provisions of ISO 3834, EN ISO 15613 and EN 1090. This requires employing a qualified welding technician or a welding engineer, according to EN ISO 14731. Furthermore all welders are qualified pursuant to ISO 9606-2. All welding procedures used are qualified according to EN ISO 15613.

#### Quality assurance

Prolyte guarantees the quality of its products with a quality assurance procedure that was developed in accordance with ISO 3834 and ISO 9001. This standard describes all steps for the manufacturing process that have an impact on the final product.

#### Product certification

All mass-produced Prolyte trusses are type-approved and load-tested by German TÜV.

### 10.2 REGULATIONS FOR ASSEMBLING TRUSSES

Assembling trusses in the event technology is differentiated according to the location where they are used:

#### 1. Outdoor truss assembly

When structures made from trusses are assembled in an outdoor environment, they are considered to be structural works and therefore are subject to building laws and the corresponding building regulations.

General building regulations assume such structures are permanent as a matter of principle (subject to general environmental influences such as, e.g., wind, snow and frost) but as truss structures for event technology are generally temporary structures, special standards and regulations exist to cover this. Structures with the same design which are intended to be assembled and dismantled in different locations are considered to be "temporary demountable structures".

There are no existing European standards on the design and construction of temporary demountable structures for the event industry, but the scope of EN 13814:2004 – "Fairground and amusement park machinery and structures - Safety" contains the words "Stages", "Grandstands" and "membrane or textile structures". As the title of this standard tells us, it is not written to reflect and in respect of the event industry as we know it.

As a result from proactive actions from a group of industry professionals, the responsible norm committee CEN TC 152 has reacted on complaints from our industry and has established a separate working group on 'Entertainment Structures'.

A particularly complicated field with regard to trusses in temporary demountable structures is the almost universal interchangeability of individual truss elements of one construction. Classic temporary demountable structures like fairground rides, have individual structure elements to have a specified position in the structure and therefore have to be checked and tested regularly by assessors.

However, for trusses there currently is no such requirement, but the national implementation of

the "Directive on Work Equipment (2001/45/EC)" makes the regular inspection of work equipment by competent persons mandatory on a regular basis. Manufacturers, users and insurers in the event industry should answer openly and honestly to all questions about responsibility, reliability and safety.

#### 2. Indoor truss assembly

When truss structures are used inside of a building, they are not considered structural works as long as they do not become a permanent part of the building, affecting the overall safety and stability of the building. As predominantly temporary technical installations, they are therefore not directly subject to the requirements of building laws.

However, truss structures do require a verification of their load-bearing capacity and stability, therefore a structural calculation shall be carried out.

The verification of the load-bearing capacity for suspended truss installations can be provided by experienced assessors using proven loading values for simple static systems.

Complex suspended structures or ground support structures generally require calculations by a qualified person. More complex structures should be calculated by a structural engineer.

Further standards and guidelines can be found in the British standard BS 7906 – "Code of practice for the use of aluminium and steel trusses and towers" and the German code of practice IGWW SQ P1 "Truss".

Since there are many differences between truss systems, the manufacturer of a truss system is obliged to provide sufficient information about the proper use of its products.

### 10.3 EUROPEAN DIRECTIVES AND TRUSS

Although truss as a product is not specifically mentioned in any European Directive or regulation, the content of these directives or regulations might affect the use of truss and its manufacturing process. This is due to the fact that in some cases truss products can be regarded as either a 'construction product' or as 'work equipment'. One of the positive effects of the European Union is the





gradual transfer of national regulations into the European system of an “integrated regulatory code/legislation”.

Directives and regulations of the European Parliament and Council affect different industries. In order to make sure to comply to these directives and regulations, we find official lists of harmonized European standards, related to safety issues and technical demands on products.

The process of harmonised European standards (EN) and Eurocodes superseding the various national standards has begun, but it takes some years to complete. Truss has a strange position from a regulatory perspective, due to the fact that truss can be used as basic component for many different applications. For permanent installations, like semi permanent installations for retail or nightclubs, normal design specifications should be used to determine the bearing capability and safety. Truss should comply with the Directive on Construction Products (305/2011/EC) if they are intended to become an element relevant for the safety and stability of a structure. For temporary structures such as ground support or roof systems as used for concerts or in exhibition stand construction, other stricter regulations, based on still existing national legislation, might be applicable. It should be evident that structures for hoisting guided loads (e.g. tower ground support) or free suspended loads (e.g. rigging towers) must be used in accordance with the directives and regulations for hoisting gear or load bearing installations.

### **European Directives that cover the design and use of lifting equipment:**

1. The Machinery Directive (2006/42/EC) is transformed into national law in all member state countries. It describes the minimum safety requirements which apply to the design and production of machinery, including machinery lifting equipment and lifting accessories.
2. The Health & Safety Directives for Employees in the Workplace (89/391/EEC) regulates the duties of employers as the parties responsible for the health and safety of employees at work.
3. The Directive on Work Equipment (2001/45/EC) defines the minimum requirements for health

and safety when work equipment is used by employees at work.

The employer must ensure that work equipment (including machinery) does not represent a danger with regard to the health and safety of employees in the workplace when it is used. This includes hoisting equipment, which was not originally planned to be used for lifting loads over persons.

### **Future developments:**

Legislation and standardisation for event technology are being developed. This special event tech segment is now regarded as an independent field of work. Similar to the integration of the safety of machinery into legislation, the legislation for lifting loads over persons is slowly being harmonised. In many EU Member States, lifting loads above persons was equated to lifting of persons. Trends in regulations and directives for theatre and event technology agree on one point: when loads are lifted above persons using conventional hoisting gear (consistent with the Machinery Directive), the ‘safety factor’ must at least be doubled. This tendency can be found in the directives and industrial standards of many EU Member States and in some drafts in the USA. A first step in this direction in the European Union was the “CEN Workshop Agreement CWA 15902-1&2” in 2008. An association of manufacturers, legal institutions and interested users acting under the aegis of the European Committee for Standardisation (CEN) that elaborates standards and guidelines which enjoy the status of recognised written cross-border technical regulations.

Recently a new technical committee has been established at CEN. The TC 433 “Entertainment technology” will adopt the results of CWA 15902 and transfer them to European standards. This work will be realized in different working groups, focusing on “Machinery”, “Work Equipment” and “Codes of practice”.

It should be emphasised that users should familiarize themselves with local, regional or national regulations, directives, ordinances or laws that deal with safety when operating hoisting devices. If no such regulations exists in a particular

country, Prolyte recommends to apply to the principle of the “double safety factor” since this is now regarded as the most important part of “best practice”. Each hoisting device, lifting accessory or load bearing element should only be loaded with half of the load bearing capacity given, when persons have to be under the lifted load “for operational reasons”.

Trusses which are a component part of a load hoisting installation, should only be loaded with half of the allowable loads given in the loading tables. Only work equipment which is intended for lifting loads over persons and has been tested for this purpose can be subjected to the full load according to the values given by the manufacturer (identification/operating instructions). In this case the manufacturer shares the responsibility if the equipment fails under normal operating conditions. Even if the 50% reduction in normal load bearing installations seems drastic, this can often be achieved easily by increasing the number of supports for large truss spans or the selection of a truss with a higher load bearing capacity. Responsible technicians that show awareness of safety and quality standards will find no difficulty in complying with this type of standards and codes of practices. Prolyte can offer training to achieve this kind of knowledge.

### Safety first

It is time to realize that economic arguments can never outweigh the safety of employees or the public. There are various institutions and organizations for quality control and certification. They all base their work on the standards of their respective countries.

In Europe the German TÜV or Swiss 5o5 is generally recognized as a leading certification authority; other well-known institutes include Lloyds (Great Britain), DNV (Norway) and Bureau Veritas (France). In Europe there are a number of recognized institutions that are accredited to certify work equipment covered by the European Directive.

Even though trusses for event technology are not dealt with in any European Directive, trusses used above persons must comply with the Directive for Work Equipment (89/655/EEC) and therefore require a risk analysis for this specific use.

### 10.4 STAGE PLATFORMS

Due to the lack of any European standard for stage platforms, the EN 13814 can be taken into account, when looking for load assumptions. Besides that, we find EN 1991, Part 1, “Actions on structures” (Eurocode 1, Part 1), demanding load assumptions on stages as part of permanent buildings.

In most cases a uniform loading capacity of 7,5kN/m<sup>2</sup> and a deflection limit of L/200 have been assumed as material design criteria for platforms, while possible point loads on the platforms have been completely ignored.

Eurocode 1 demands a uniform loading capacity of 5kN/m<sup>2</sup> and a point load of 3,5kN – 7,0kN on an area of 5cm x 5cm, while EN 13814 prescribes a uniform loading of just 1,5kN/m<sup>2</sup> for stages not open for public access, a uniform loading capacity of 3,5kN/m<sup>2</sup> for areas with universal public access and no point load at all.

Looking at the requirement of Eurocode 1, compared with the technical data of birch plywood, the minimum board thickness would be 35mm – not applicable in the event industry. Therefore the German standard DIN 15921 “Entertainment technology — Aluminium platforms and frames — Safety requirements” has been developed, providing load assumptions adequate for the entertainment industry.

Different standards define values for horizontal forces. These are caused by movements on platforms (e.g. by dancers or stage machines) and additional loads created for example by loads on railings. EN 13814 requires a horizontal load bearing capacity for stages of 10% of the allowable vertical loads; the British standards classify horizontal load-bearing capacity in three classes between 5% and 10%. For synchronous (rhythmic) movements the requirement is also 10%.

As a general rule it can be assumed that outdoor stages shall withstand a horizontal loading of 10% of the vertical loading and indoor stages shall withstand a horizontal loading of 5% of the vertical loading. Looking at the requirements for stage legs, where, for a standard platform of 2 m x 1 m with an allowable vertical load of 750 kg/m<sup>2</sup> (that is 1500 kg uniformly distributed load) each of the four legs



has to be able to bear a horizontal load of 37.5 kg (10% of 1500 kg = 150 kg / 4 = 37.5 kg). When using circular tubes as legs at a height of 100 cm, tubes with at least 48.3mm x 4mm of the alloy EN AW-6082 T6 should be used.

If stage elements are connected to each other to create a stage area, the allowable load bearing capacity could be reduced if the full number of legs is not used.

Prolyte would like to explain this clearly and therefore has published tables with loading data depending on the length and material of the legs.

### 10.5 STAGE LEGS & RAILINGS

Principles relating to the use of legs for stages as in the case of trusses, Prolyte also provides information on the load a stage element can support, based on the fact that a stage must be able to withstand a horizontal loading of 10% of the vertical loading.

The horizontal force which a stage element can absorb, depends on the following points:

- Diameter and wall thickness of the leg.
- The leg alloy.
- The leg length.
- The leg connection.

Picture A

4	2	2	2	2	2	2	2	2	2	2
2	1	1	1	1	1	1	1	1	1	1
2	1	1	1	1	1	1	1	1	1	1
2	1	1	1	1	1	1	1	1	1	1
2	1	1	1	1	1	1	1	1	1	1

"stage 10x10 m. based on hang-on leg system"

Respectively 4, 2 or 1 leg per stage element

The values stated by Prolyte for the load of their StageDex, versus the height and the legs used are limited by the leg connection. This directly implies that the use of fewer legs means either that the allowable load is less or that the permissible horizontal force of 10% has to be adjusted downwards.

### Railing for Stages

Whether a railing has to be fitted to a stage or not, is a subject of much discussion. The load that a stage railing has to be able to withstand depends on the use. A distinction has to be made as to whether the stage is open to the public or not.

In the case of most pop music stages, a railing that can withstand 30 kg/m is considered to be sufficient. A railing such as this is a clear indication of where the stage ends.

#### Load reduction example:

If a 100m<sup>2</sup> stage normally has 200 legs, (4 per 2m<sup>2</sup>, (picture B)), this will change to 66 in the case of a 'hang-on' system (picture A).

The load can then be multiplied by a factor of 66/200= 0.33. If the load used to be 750 kg/m<sup>2</sup>, this will then become 247.5 kg/m<sup>2</sup>.

Picture B

4	4	4	4	4	4	4	4	4	4	4
4	4	4	4	4	4	4	4	4	4	4
4	4	4	4	4	4	4	4	4	4	4
4	4	4	4	4	4	4	4	4	4	4
4	4	4	4	4	4	4	4	4	4	4

"stage 10x10 m. based on 4 legs per stage"

## 10. APPLICABLE LEGISLATION AND REGULATIONS

By contrast, diverse requirements are “in the air” when looking for the demands of railings for platforms or grandstands with free public access. The load requirements reach up to 300kg/m at a railing height of 1m.

Such loads cannot be accommodated by existing stage floors, or only with considerable trouble and effort. In particular, the dispersal of the forces is a mayor challenge. The connection between railing, stage and sub-construction has to fulfil stringent requirements.

Polyte relates to DIN 15921 providing railings to withstand a horizontal load of 1kN/m, which means that a 2m railing is able to absorb 2kN.

### 10.6 STANDARDS AND REGULATIONS FOR ELECTRICAL HOISTS

#### Industry versus Entertainment application

Hoists as used in the entertainment industry are almost identical to the original industrial versions. The major difference is the use and the position of the hoist vis-à-vis the load. In an industrial environment, a hoist tends to be permanently suspended in what is referred to as a motor-up position, with the hoist being attached to the support structure. In an entertainment situation, hoists are generally used in a motor-down position, whereby not the hoist but the lift chain is attached to the support structure while the hoist stays in the proximity of the load.

The advantage of this is that the cabling can be fitted at operating height and that, instead of the heavy motor housing, the relatively lighter weight of chain needs to be lifted and handled by the rigger.

#### People located under a live load

Another major difference is that, in the entertainment industry, loads are suspended or moved above people’s heads. In a lot of EU countries this Work Equipment (2001/45/EC) is only permitted if additional safety measures have been taken. The Machine Directive 2006/42EC (European legislation) refers to a doubling of the working coefficient when people are lifted. Within the meaning of this directive it can also be asserted that the same applies to lifting above people’s heads.

It is unclear whether this directive also applies to immobile suspended loads above people’s heads, a situation that is a regular occurrence in the entertainment industry. The European Code of Practice CWA 15902-1, as well as existing standards such as BS 7906-1 / FEM 9756 leave open the possibility of using a ‘standard’ hoist provided a risk analysis shows this to be justifiable.

The Dutch Code of Practice NPR / FEM 8020-10 states that the use of a standard hoist is permitted in this situation provided the working coefficient is doubled, such in accordance with the machine directive. In such cases, a 1.000-kg hoist can only be used for 500 kg. In Germany, a hoist known as a D8+ has to be used in such situations. Besides having a double working coefficient, this hoist also has a double braking system.

#### Lifting loads above people

As regards moving loads above people’s heads it may be necessary to use special hoists. In addition to having overload and underload protection, these hoists may have an operating system that checks the mutual position of the hoists and monitors the loads.

In the event of any deviation from the set parameters, the system switches off, thereby guaranteeing safe usage. Such a system is often referred to as a DGUV V17. In Germany such systems are governed by the regulations of the DGUV [German prevention & insurance association].

The equipment and operating technology used depends very much on the situation during hoisting:

- A load on a single hoist makes different demands on hoisting and controlling than a load lifted by four hoists, certainly if more than one of these loads is controlled by one and the same system.
- If the operator has a clear overview of the load and the immediate environment in which hoisting is to take place, it will always be possible to take action in the event of danger.
- What the chance of failure is, and what the risks for all the components used, and their combinations, are.



Photo: Interstage, Concert at Sea, Space Roof

## 10. APPLICABLE LEGISLATION AND REGULATIONS

Currently, a whole series of standards apply to the operation of machines and systems with a safety function. IEC 62061 applies specifically to machine building. This standard is derived from IEC 61508 and deals with the issue of how a safety system can be produced using combinations of 'simple' software, electronics and electrical components. IEC 62061 relates to the specification of the safety level of the specific part of the machine's controls that has a safety function and also assesses the whole range of software, electronics and electrical components. This is expressed as a SIL level. Simultaneously with IEC 62061, the ISO 13849 standard was created for the mechanical part and components. This standard applies from the mechanical point of view to the reliability of components at component level, instead of to the whole. This standard allows the category and the PL (performance level) of a component to be determined. On contrast to systems, components cannot be categorised into a SIL level.

### Double brakes

The use of a double brake is a point that has become open to question. If a hoist generates a doubling in the working coefficient (NPR 8020-10 and D8+), this means that all settings, including those pertaining to the slip clutch and the brake, are increased by a factor of 2 with respect to the operating load.

Fitting 2 brakes to the same shaft would only be advantageous if one brake were to fail. The question is what would happen if the shaft broke, or if one of the brakes no longer worked? You would not notice any change and yet you would still think you were working safely! The double brakes requirement is derived from the German regulations as drawn up by the DGUV and from the theatre standard DIN 56950-1.

### Secondary suspension

What if I do not have a hoist which complies with the above-mentioned standards? Am I obliged to dead hang my load, or do I have to attach a separate suspension device? The lack of specific regulations in the majority of countries means this point is unclear. However, one can state that a chain hoist used to hoist a roofing system must

be relieved of the load at all times. In the context of suspending a truss construction, the fitting of a dead hang often entails major risks which are not justified by the increase of the overall safety. The bridging of a chain hoist using a chain clutch is a method which is strongly advised against.

### Visual inspection and testing

As is the case with other equipment and machines, the suitability of a hoist must always be assessed before use. This assessment is normally a visual one. If a hoist is used for a long period of time in a hazardous environment, the hoist must be tested (inspected) by a competent person in accordance with the supplier's requirements. Examples of such situations are long-term use outside, use in the rain, use in the vicinity of salt water or use in a sandy environment. Inspections must take place as frequently as is necessary.

Each electrical hoist must be tested at least once a year. The tests and inspections must be performed by a competent person. The person who requests the test/inspection is responsible for making sure that the testing person or company is competent. Therefore in most countries, hoisting and lifting materials, such as those used in the entertainment industry, can be inspected and tested by a 'competent person'. Do not allow yourself to be confused by people who claim that this work has to be done by an 'accredited or notified body'. However, a notified body does generally have to be called in to test and inspect cranes and passenger lifts.

### Duty factor

Chain hoists are classified using what is known as a duty factor. The operating time and starts/stops (indicated in percentages of an hour) indicates how long a hoist may be used at a full load.

A 2m classification indicates that a hoist has a 40% operating time with a minimum of 240 starts and stops per hour. This means that a hoist with a hoisting speed of 4 m/min can hoist a maximum distance, with a full load, of  $4 \times (60 \times 40\% = 24) = 96$  metres.



### IP Explanation and Ratings

EN 60529 outlines an international classification system for the sealing effectiveness of enclosures of electrical equipment against the intrusion into the equipment of foreign bodies (i.e. tools, dust, fingers) and moisture. This classification system utilises the letters 'IP' ('Ingress Protection') followed by two or sometimes three digits.

(An 'x' is used for one of the digits if there is only one class of protection; i.e. IPX4 which addresses moisture resistance only).

#### Degrees of Protection - First Digit

The first digit of the IP code indicates the degree to which equipment is protected against solid foreign bodies intruding into an enclosure.

- 0 No special protection.
- 1 Protection from a large part of the body such as a hand, from solid objects > 50 mm in diameter.
- 2 Protection against fingers or other objects not greater than 80 mm in length and 12 mm in diameter.
- 3 Protection from entry by tools, wires, etc., with a diameter of thickness greater than 1.0 mm.
- 4 Protection from entry by solid objects with a diameter or thickness greater than 1.0 mm.
- 5 Protection from the amount of dust that would interfere with the operation of the equipment.
- 6 Dust tight.

#### Degrees of Protection - Second Digit

The second digit indicates the degree of protection of the equipment inside the enclosure against the harmful effects of various forms of moisture (e.g. dripping, spraying, submersion, etc.).

- 0 No special protection.
- 1 Protection from dripping water.
- 2 Protection from vertically dripping water.
- 3 Protection from sprayed water.
- 4 Protection from splashed water.
- 5 Protection from water projected from a nozzle.

Hoists are also often used outside, for example at festivals or outdoor events. ProLyft hoists comply with protection class IP54. Classification 4 means that a hoist made in accordance with IP54 is not suitable for use in torrential rain! The hoist always has to be protected with a cover when used outside.

### WLL versus SWL

Working load limit is the capacity of hoisting equipment or hoisting tools. SWL is the operating load of a system of hoisting equipment and hoisting tools.

#### Example:

A H30V truss with a 4 metre span is suspended from two 500 kg hoists. The WLL of the hoist is therefore 500 kg. The H30V truss at a span of 4 metres has a WLL of 1,965 kg.

The SWL is in this case 2x the lifting capacity of the hoists = 1,000 kg – own weight of the truss = +/- 975 kg.

## 11. SLINGING AND SUPPORTING TRUSSES

### 11.1 RELEVANCE OF THE METHOD OF SLINGING

A lot can be said about methods of slinging trusses. Plyte encourages all users of trusses to use the best and safest method of slinging trusses. However, it should also be mentioned that our experience with known truss accidents has shown that the method of slinging plays a subordinate role only.

There are three main reasons for truss structures to fail or for accidents with trusses:

- A.** Overloading a truss section; too high pay loads in a truss section, frequently in combination with dynamic load such as:
- B.** frequent interruptions of the lifting processes, persons climbing, lifting devices or winches sling to suspended trusses (mother grid),
- C.** moving trusses catching or hooked behind building sections, stage superstructures or other rigid obstacles that lead directly to extreme overloading and damage (the operator of hoisting devices must be able to supervise the whole lifting distance of a suspended structure at all times and should not be distracted), overloading of chords between two node points of a truss (large point loads should always be placed in the node points or in the immediate vicinity).  
See 11.6 and 11.7

The type of slinging is of importance when shear forces and/or in combination with bending moment are the limiting factor for the strength of a truss structure (see 11.6/2).

### 11.2 SLINGING METHODS

When slinging trusses at first a differentiation must be made between temporary and permanent installations.

For permanent installations mostly rigid attachment devices are used to hold the trusses in position. Rigid slinging devices may only be used for straight vertical support, diagonal pull is not permissible for lifting brackets and truss clamps. Therefore the use of rigid slinging devices in a truss bridle is not permitted.

For temporary installations, such as used for concerts, mostly flexible devices are used, to allow the freely suspended truss to react to horizontal

loads. Round slings with a steel wire core or wire rope with a protective sleeve are used in conjunction with shackles.

### 11.3 SLINGING DEVICES

#### Round slings

When handling aluminium tubes, soft and non-abrasive slinging devices are needed. Round slings would be the perfect choice. Unfortunately round slings are made of polyester that melts at ca. 250° C.

The allowable temperature for round slings in use is 100° C. Most countries have fire protection regulations that prohibit the use of round slings near sources of heat.

Accidents have occurred which were definitely caused by melted round slings. If round slings are used, a second non-flammable safety device made of a steel wire or chain must be added.

#### Round slings with steel wire core (Soft Steel®)

The flexible slinging device Soft Steel differs from conventional round slings with its non-flammable steel wire core. Soft Steel is almost flexible as polyester round slings, but does not require steel wire as a second safety due to its high resistance to heat. The polyester material of Soft Steel is black, the identification label is silver grey and an inspection window covered with a Velcro strap means the steel wire core can be inspected. Soft Steel complies with all CE requirements. For the chord of a truss Soft Steel should be the preferred device over a steel wire since it offers a considerably wider support area.

#### Steel wires

A further flexible slinging device is a steel wire rope compliant with EN 13414. Direct contact between the steel wire rope and the truss chord should be avoided because of the abrasive surface of the steel wire rope. In this case plastic steel wire should be used. Since this is prohibited in Germany, sliding protective sleeves on the steel wires are used. Since the sleeves can be slid along the steel wire rope, this enables the whole steel wire rope to be inspected. Apart from protecting against wear, the sleeve also acts as heat insulation. Slinging wires of





type N with fibre core and aluminium crimp sleeves lose load bearing capacity above a temperature of 100° C, with a steel core from 150° C. Slings wires of type F (Flemish eye) always have a steel inlay and steel crimp sleeves. They lose their nominal bearing capacity above 250°C.

Good resistance to heat is always a good thing in slinging devices. However, if they are considerably better than the temperature susceptibility of the truss, their effectiveness reaches a sensitive limit. Aluminium alloys lose tensile strength with increasing temperature. Above 75°C this is only 95 % of the nominal tensile strength, above 100°C it is 85 %, above 150°C 70 % and at 200°C it is only 50 %.

It should be emphasised that in tropical areas with a massive use of conventional flood lamps or in film and TV studios where lamps are used uninterruptedly over long periods, there is a certain potential danger of trusses overheating. Steel wires are difficult to use in view of the preferred slinging methods with slings and sleeves. This reduces the possibilities of finding an optimum slinging method.

### Chains

Chains can withstand higher temperatures, but absolutely require a protective sleeve and can only be used with difficulty for the preferred types of slinging. Even if the requirement foresees working temperatures above 200° C, the user must be aware that trusses made of aluminium are no longer sufficiently stable.

At such high working temperatures steel trusses should be used. If chains are preferred as slinging method for aluminium trusses, the user will have to provide the arguments in favour, particularly if other slinging devices are as good or even better for most applications.

### Lifting Brackets

The final slinging device worthy of mention is a lifting bracket with lifting eyes. These brackets can be produced for most truss series and have a property in common, namely that horizontal forces between the chords can be ignored and that heat resistance is not of significance.

Lifting brackets are made of steel or aluminium, depending on the type of truss.

A small disadvantage is that these adapters can not be placed directly in the node points of a truss, but only close by and that mounting them, particularly in the lower chords, is time-consuming. For permanent installations this limitation is irrelevant, therefore lifting brackets are very common. Since the lifting bracket is not fully comparable with standardised slinging methods, they will not be discussed further. Diagonal pull is not permitted when using lifting brackets or pipe clamps.



Lifting Bracket WLL 500kg



Lifting Bracket WLL 1000kg

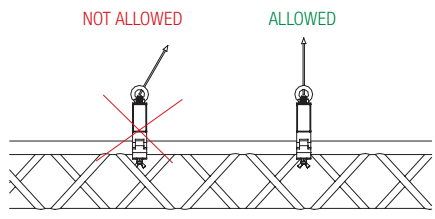
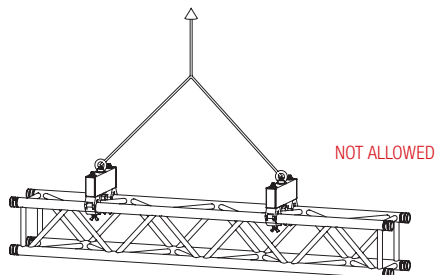

# 11. SLINGING AND SUPPORTING TRUSSES

## 11.4 SLINGING TRUSSES

All types of slinging worldwide are based on four basic types of slinging are:

1. Direct Hitch
2. Choke Hitch
3. Basket Hitch
4. Multiple legs

The various slinging variants for trusses are always composed of a combination of these four slinging types. The larger the contact area between a slinging device and the truss chord, the better loads can be directed into a truss. If the chord were to rest on a nail, the forces on the contact area would be multiples of the forces if a 50 mm clamp is used with an effective support area of approximately 1/3 of the circumference of the chord. Naturally no one would rest a truss on a nail, but steel wire and chains have a very small support area with direct contact and therefore can easily damage the chords. This should be considered particularly in the case of relatively thin-walled chords of only 2mm or even less.

Tests have shown that even fibre-reinforced nylon sleeves 3 mm thick used as a protective covering for steel wires with a diameter of 10 mm have a limit to their use. Support loads of around 1800 kg (i.e. 900 kg per chord) lead to complete destruction of the nylon layer between steel wire and chord. Only the reinforcing fibres remain. The protection from damaging the aluminium tube by the steel wire is lost. If steel wires with a protective sleeve are used to hitch trusses, they must be checked systematically.

A further possibility to protect the chords is to use slotted plastic pipes placed over the chords in the required pick-up point. This protection measure can be made quite easily with commercially available waste pipes with a section cut out. In this case "naked" steel wire can be used because regular replacement of such a cheap means of protection cannot be problematic to anyone with a healthy respect for safety.

Chains are used fairly seldom to sling trusses since they are relatively expensive and using protective sleeves for chains to protect the chords makes slinging the truss very difficult. Basically the type of slinging should compensate primarily for the

shear forces in the vertical plane of the truss. The method of slinging has considerably less influence, if any, on the safety of a free truss span in relation to the bending moment. Care must be taken with the type of slinging on the inner supports for multi-span trusses, where the tension and compression forces reverse in the chords. Here the truss must be attached in the nodes.

### 1. Direct hitch (DH)

This type of slinging is only used in conjunction with lifting brackets or when pick-up points are already present. Flexible slinging devices (round slings, steel wire or chain) are connected with a hook or a shackle.

### 2. Choke hitch (CH)

This type of slinging should only be used with two identical flexible slinging devices at one attachment point. One flexible slinging device holds one side of the truss cross-section. The slinging devices are tied around a lower chord and wrapped around an upper chord before they are connected to each other using a shackle or hook. Steel wires and chains are unsuitable for this method. It should be noted that this type of slinging reduces the load-bearing capacity of the individual slinging devices by the sling factor of 0.8 and the angle between the ends of the slinging devices means an additional reduction in the load-bearing capacity of 30% to 50%. This should be reflected in the loading tables provided by the manufacturers of flexible slinging devices.

### 3. Basket hitch (BH)

For this type of slinging the slinging device is fed underneath the truss and wrapped once around the lower chord or is passed upwards at each end of the truss and wrapped once around the upper chord before the ends are connected using a hook or shackle. The load-bearing capacity of the slinging devices is improved by the sling factor 1.4 – 2, depending on the angle between the sling ends. The angle may not be greater than 120°. Care should be taken that the slinging device is used close to a horizontal brace so that this can absorb the compression forces between the upper chords.



Photo: Showtech, Dubai. Build of a ST Roof.

#### 4. Multiple legs

As with basket hitches the top angle of a multiple leg (bridle) should not exceed a certain angle. The reasons for this is that load capacity of the sling will drop and horizontal forces in the construction lifted might increase to unwanted high levels. Reference to capacity should be taken from product labels on which reduction factors and allowable angles should be mentioned.

#### Wrapping main chords

This method is basically used in connection with the choke or basket hitch and primarily to include the upper chord of a truss. Furthermore it is used for horizontal stabilisation of a truss. The loadbearing capacity of the slinging device is not reduced if the wraps are performed cleanly. Prolyte always advises using choked hitch with two identical flexible slinging devices. All truss chords should be included in the hitch.



Photo: Rigging Course, with Rinus Bakker of Rhino Rigs

### 11.5 COMMONLY USED SLINGING METHODS

In order to determine the appropriate slinging method a couple of technical aspects need to be considered:

#### 1. The position of the support points within the truss

**A.** Trusses are calculated as single spans, suspended or supported at both ends at the position of the end braces. You can attach a sling to either the upper chords or lower chords in or very close to the node points without losing strength. All truss members help to transfer the forces, which are caused by the pay loads, to the suspension/support points. Forces in diagonals are alternating, they can be subject to tension or compression, depending on their position in the span. For diagonals in aluminium truss the allowable force in tension and compression is equal. However, if overloaded to the point of failure, a diagonal loaded in tension will snap, while one in compression will buckle as the failure mechanism. Therefore it is advised to have the first diagonal under compression, because if failure occurs, the consequences are less fatal.

- B.** Slinging shall be applied in the node points. If slinging is applied within 10 cm from the node the full load can be applied for 30 and 40 series, and a maximum of 2000kg for S-series (see also 11.6)
- C.** Trusses without vertical end braces must be treated with utmost care. These trusses must always be supported at a node point.

#### 2. Stabilisation of the suspended truss

- A.** Trusses can rotate due to eccentric loading, e.g. hanging lamps on one side at one chord only. The truss must be prevented from rotating at all time since it is not calculated for rotated positions. A common method is to wrap a sling around all chords and thus increase friction to prevent the truss from rotating. Raising the wraps elevation increases stability and reduced horizontal stresses in the truss cross section .
- B.** In a closed grid or a ground support, trusses can rotate much more difficult. A corner block or sleeve block prevents them from doing so. In those situations other slinging methods can be used as well.



C. In case of tilting trusses or truss grids, suspensions are subject to changing forces due to the shift of the point of gravity of the load. For these applications we advise to wrap all chords.

### 3. Arrangement of diagonals

- A. For trusses, such as the Prolyte 36, 52, 66 and 100 series (except folding trusses), with diagonals running parallel at two opposite sides, slinging can be applied in a node at the top or bottom chords, since the node points are laterally connected by cross bracing, which bears compression forces within the truss caused by slinging.
- B. For trusses with an alternating diagonal pattern such as the Prolyte 30 and 40 series, a slinging method where all chords are wrapped -1 quarter of the full node to node distance- fulfills all demands. This method guarantees that the slinging is never attached in between node points.

### 4. Position of the suspension or support in a span.

- A. At the end of a span, at its support points, a truss is only subject to shear forces in the main chords and normal forces in the diagonals (see 3.4). The bending moment is assumed to be absent.

B. At intermediate supports of a multiple supported truss, the truss is subject to bending moments as well shear forces. Suspending the truss on that position by only slinging two of the main chords (e.g. a lifting bracket), adds an additional bending moment to the main chords. Furthermore the support reaction in these intermediate points is much higher. This shall all be minimised in its possible effect. Therefore we advise a slinging method which wraps all chords.

With literally hundreds of possibilities to sling the trusses, and over 10 parameters to judge them on safety, it is beyond the scope of this BlackBook to discuss them all in detail. The methods below are those approved and advised by Prolyte.

**Slinging of truss may only be applied in - or close to - the node-points.**

Prolyte points out that using 2 similar slinging devices for each suspension point is advised due to redundancy. In case of full loading all main chords should be supported.

Preferable support should be at the lower chords as a result of risk reduction actions taken.

# 11. SLINGING AND SUPPORTING TRUSSES

TRIANGULAR TRUSS | APEX UP

1 SLING, INVERTED BASKET ON BOTTOM CHORDS



1

TRIANGULAR TRUSS | APEX DOWN

1 SLING, BASKET ON BOTTOM CHORD AND WRAPS ON TOP CHORDS

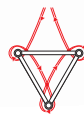

2

TRIANGULAR TRUSS | APEX UP

2 SLINGS, CHOKES ON BOTTOM CHORDS



3

TRIANGULAR TRUSS | APEX DOWN

2 SLINGS, CHOKES ON TOP CHORDS

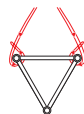

4

TRIANGULAR TRUSS | APEX DOWN

1 SLING, INVERTED BASKET ON TOP CHORDS

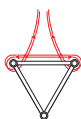

5

TRIANGULAR TRUSS | APEX DOWN

1 SLING, BASKET WITH WRAPS ON TOP CHORDS

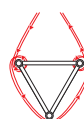

6



RECTANGULAR TRUSS

2 SLINGS, CHOKES ON TOP CHORDS

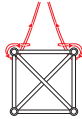

7

RECTANGULAR TRUSS

2 SLINGS, CHOKES ON BOTTOM CHORDS



8

RECTANGULAR TRUSS

2 SLINGS, CHOKES ON BOTTOM CHORDS WITH WRAPS ON TOP CHORDS

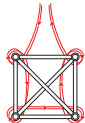

9

RECTANGULAR TRUSS

1 SLING, INVERTED BASKET ON TOP CHORDS

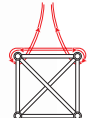

10

TWO CHORD TRUSS

1 SLING, BASKET ON TOP CHORD



11

Note: Never sling straight spans of two chord truss at the bottom chord!



Learn more at a Prolyte Campus event.

### 11.6 SUSPENDING/SUPPORTING TRUSSES OUTSIDE NODE POINTS

When using lifting gear it is often not possible to attach these where the diagonals intersect. This can lead to a reduction in the load-bearing capacity of the truss, depending on the position of the suspension points and the number of suspension points per span.

If the truss is not supported in the node point but at the main chord, this chord will be subject to additional forces (bending moment).

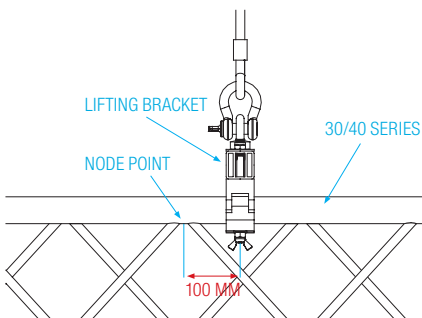

#### 1. Truss supported at each end of the span, max. 10 cm outside the node point

At the end of the truss the bending moment is almost zero. This means that the main chord is not subject to normal forces. The only load is caused by the lifting bracket.

Resulting load-bearing capacity:

If the lifting bracket is attached 10 cm from the node, trusses may be subjected to the following loads:

- Prolyte X30, H30, X40 and H40 series 100% of their load-bearing capacity.
- Prolyte S-series max. 2000 kg per support point.

#### 2. Multiple supported trusses

If a truss is suspended at more than 2 points, the suspension points in between have to be attached into the node points. If this is not done, the truss may not be loaded to 100% of its load-bearing capacity. Slings to all main chords does nothing to change this. The correct load can only be determined by studying each load case individually.





Support points at multiple supported trusses, 2 forces need to be considered:

- A. Because of the own weight and payload on both sides of the support, the truss is subject to bending moments. This results in compression of the bottom chord and tension in the top chords.
- B. An additional bending moment in the main chord occurs because of the mis-noding of the lifting bracket. An interaction of both forces means that the permissible load-bearing capacity of the support point can only be determined on a case-by-case basis. In general the load should be substantially reduced.

Loading the outer sections of the truss span to the maximum means there are hardly any reserves for the support points. In a worst case scenario, the support point can be loaded with only 100 kg. (See max. allowable point load for free chords at the bottom of each truss loading table in the brochures).

### 11.7 LOADS AT FREE CHORDS IN BETWEEN TWO NODE POINTS

Allowable loading between two node points - free chords - is affected by:

- The length of the total span.
- The size of the total span.
- The size of the HAZ at node points at both tube ends.

The loads given are calculated in such way that it does not matter whether:

- They apply to top or bottom chords.
- Loads are suspended at adjacent fields.

The sum of all point loads may not exceed the maximum allowable loading of the truss.

In case of having just one point load to be suspended at a free chord length, the load might be higher however this should be checked by an engineer.

#### Allowable loading between node points per truss type:

X30D	=	120 kg
X30V	=	90 kg
H30D	=	130 kg
H30V	=	100 kg
H40D	=	90 kg
H40V	=	60 kg
S36R/V	=	150 kg
S52V/SV	=	80 kg
S66R/RV	=	70 kg
B100RV	=	140 kg

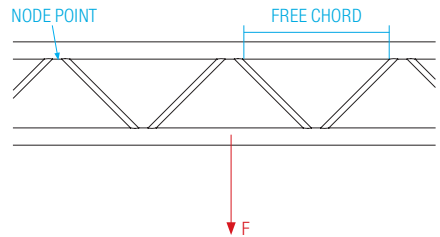

## 12. PRACTICAL TIPS FOR PROLYTE TRUSSES

### 12.1 DIMENSIONS FOR COMBINATIONS OF SLEEVE BLOCKS AND CORNER ELEMENTS

This diagram shows the length of a centre truss using standard T-corners (H40V-C017) in an MPT-tower system with CCS6-602 connections:

The length of the straight pieces between two T-corners H40V-C017 is  $2 \times 187 \text{ mm} = 374 \text{ mm}$  less than the length used between the sleeve blocks.

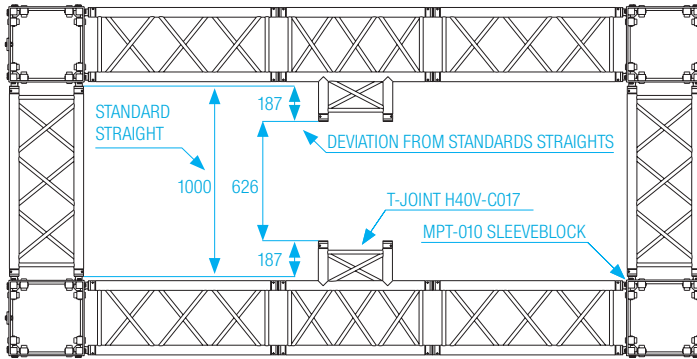

Figure: H40V-C017 with MPT seeve blocks

This diagram shows the length of a centre truss using box corners (BOX40V + CCS6-651) in an MPT-tower system with CCS6-602 connections:

The length of the straight pieces between two T-boxcorners BOX-40V is  $2 \times 51.5 \text{ mm} = 103 \text{ mm}$  less than the length used between the sleeve blocks.

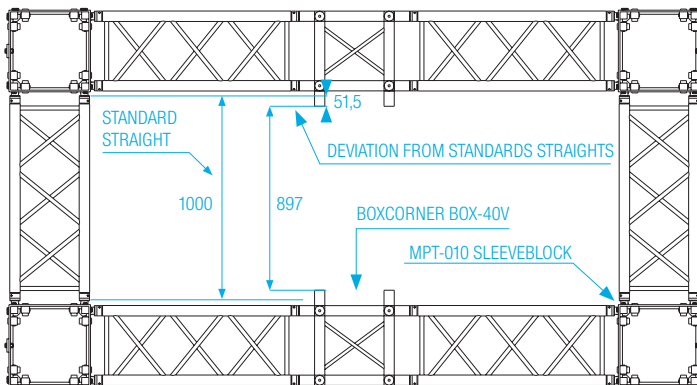

Figure: BOX-40V with MPT sleeve block



This diagram shows the length of a centre truss using box corners (BOX40V + CCS6-652S-23,5) in an MPT-tower system with CCS6-602 connections:

The length of the straight pieces between two T-Boxcorners with CCS6-652S-23,5 is equal to the length used between the sleeve blocks. No specials are required!

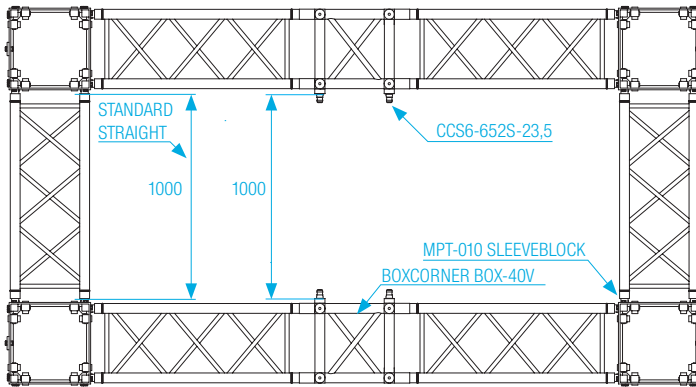

Figure: BOX-40V with MPT sleeve block

This diagram shows the length of a centre truss using standard T-joints (H30V-C017) in an MPT-tower system with CCS6-602 connections:

The length of the straight pieces between two T-joints H30V-C017 is  $2 \times 137 \text{ mm} = 274 \text{ mm}$  less than the length used between the sleeve blocks.

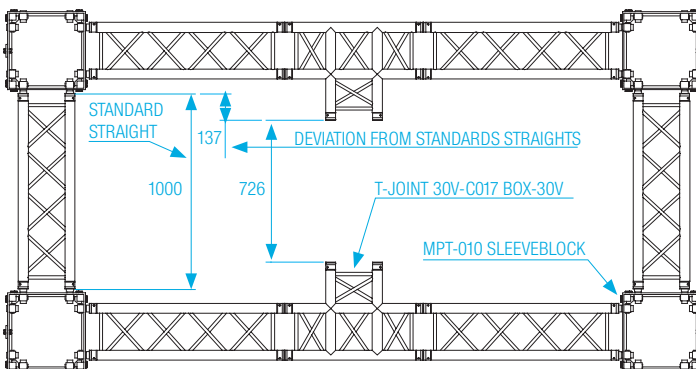

Figure : H30V-C017 with MPT sleeve blocks

## 12. PRACTICAL TIPS FOR PROLYTE TRUSSES

This image shows the length of a centre truss using box corners (BOX30V + CCS6-651) in an MPT-tower system with CCS6-602 connections:

The length of the straight pieces between two T-boxcorners (BOX30V + CCS6-651) is  $2 \times 1.5 \text{ mm} = 3 \text{ mm}$  less than the length used between the sleeve blocks. Prolyte can deliver special lengths or spacers.

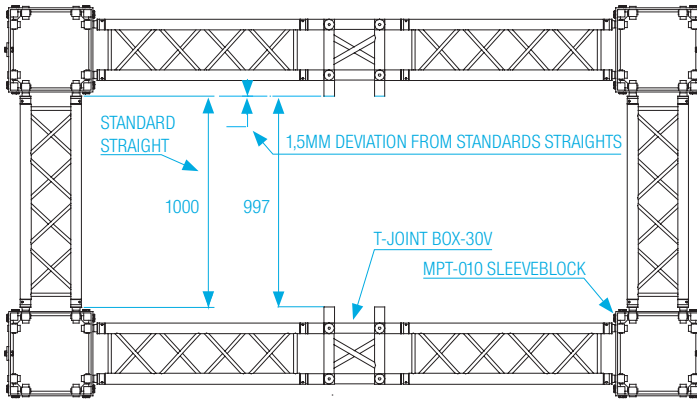

Figure: BOX-30V with MPT sleeve blocks



## 12.2 HINGES OR HINGE ELEMENTS

Hinges are primarily used in tower systems, but also and increasingly in special structures. Below we explain the hinge types for three and four chord trusses of the X/H series as well as for trusses of the S/B series.

The hinge most commonly used is CCS6-H. It is used in all MPT and ST tower systems as well as the rigging tower RT-H30V. CCS6-H is a single hinge set and is composed of a fork hinge CCS6-H-FM-45° (A) and a pin hinge CCS6-H-M-135° (B) together with a locking pin ACC-LP016 and safety pin CCS7-705.

The degrees show the angle of the conical drillhole in the direction of the hinge. The hinge always lies at right angles to the hinge axis. Older CCS6-H hinges are not identified, new CCS6-H hinges are engraved with their degree values.

Hinges for trusses of the S/B series are only given in individual pieces. A complete "set" for a four-chord truss of the S/B series consists of the hinge pin CCS7-H-60-M-0° and CCS7-H-60-M-90° and the hinge forks CCS7-H-60-FM-0° and CCS7-H-60-FM-90° as well as the locking pins ACC-LP20/60 and safety pin CCS7-705.

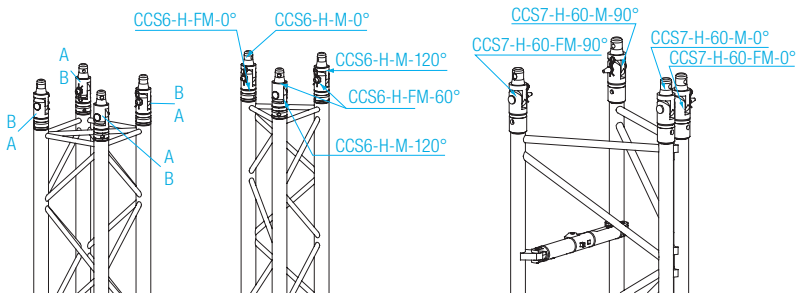

A = CCS6-H-FM-45°

B = CCS6-H-M-135°

## 12. PRACTICAL TIPS FOR PROLYTE TRUSSES

DO



DON'T



### 12.3 USING HOISTS IN A GROUND SUPPORT SYSTEM

A ground support is lifting a device which can lift a guided load to a desired height using hoists. In a number of countries a distinction is made between lifting a free load and lifting guided loads. In the case of a guided load, and therefore also in the case of a ground support, one has to take into account the friction caused by the guide. This friction depends on the type of wheels and the sagging of the span between the sleeve blocks. A general rule of thumb is that, if a load is lifted using more than two hoists, the hoists may be used to a maximum of 75% of their capacity. Prolyte advises that this rule be observed in the case of ground support systems.

#### Attaching hoists in a ground-support system

Two methods can be used to attach hoists in a ground-support system:

- The hoist is fixed to the base and the hoist hook to the truss. The operating load of the truss will then be equal to the hoisting load of the hoist. However, part of the self weight of the trusses and sleeve blocks does have to be deducted.
- The hoist is attached to the truss and the hoist hook to the sleeve block. This doubles the lifting capacity but halves the lifting speed. Here too, the self weight of the truss construction has to be deducted from the lifting capacity in order to determine the SWL of the construction.

A: LOAD CAPACITY TRUSS

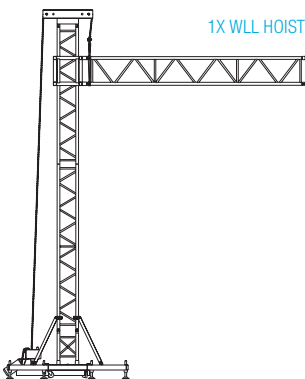

B: LOAD CAPACITY TRUSS

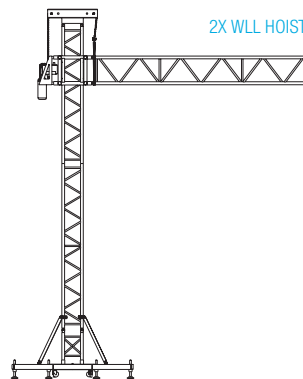



Photo: TSD Group, Argentina

It is very important that the hoist hook and lift hook run in line with the direction of forces.

It is not permitted to have the lift chain run with a fleet angle into the chain hoist nor to attach the load hook at an angle, for example to the sleeve block, because this will exert a side load on the hoist housing.

#### 12.4 ELECTRICAL POTENTIAL EQUALISATION FOR TRUSS SYSTEMS

The user needs to ensure that truss systems that might develop dangerous touch voltages in the event of an electrical fault are incorporated into a common potential equalisation system. This applies to all elements made of electro-conductive material which have equipment placed on, or attached to, them or across which wires and cables run that, in the event of damage, could make electrical contact with metal parts. The connections can be made with clips, pipe clamps, screw joints or special single-pole locking connectors.

The common potential equalisation system must be connected to the earth wire of the electrical power supply system. For cable lengths of up to 50 metres, 16 mm<sup>2</sup> Cu is considered the standard value for an

adequate cross-section. For cable lengths of up to 100 metres, the standard value is 25 mm<sup>2</sup> Cu. In truss-tower systems, the potential equalisation connection can be made by means of a potential equalisation connection point provided by the manufacturer at the tower base. Since the wheels or rollers used in tower systems with 'sleeve blocks' insulate the movable part of the truss construction, the latter must be provided with a separate potential equalisation connection.

Protection against lightning strike. Electrical installations in temporary structures should be adequately earthed in accordance with normal standards. Consideration should be given to the degree of exposure and likely risk of strike by lightning and, where appropriate, the structure itself should be adequately bonded or earthed. Advice on earthing and lightning protection should be sought from an electrical engineer.

In ground-supported constructions the main grid is quite often isolated from the towers because of the use of plastic or rubber castors in sleeve blocks. Thus the main grid needs to be earthed separately, by an earth cable coming down with all other electrical cables.

## 12. PRACTICAL TIPS FOR PROLYTE TRUSSES

### 12.5 PRE-TENSIONING OF TRUSSES (PRE CAMBER)

In the case of some applications it is not desirable for a truss to sag. Examples are a projection screen that has to hang perfectly flat. There are various ways of minimising truss span sagging or even reducing it to nil.

- A. Select a truss with a larger cross section elevation. If a truss is constructed using the same materials but with a larger height, the moment of inertia will be greater and the same load will cause the truss to sag less.
- B. Support the truss, for example, by attaching a steel cable to the end of the truss span and passing it via a turnbuckle attached underneath the truss in the middle. The steel cable will then absorb all tension forces.

The truss is loaded to pressure. This method can be used to increase the load limit of the span. However, the steel cable attachment points will generate such a high force that special attachment points will have to be created.

- C. Place extended spacers in the upper edge of the truss. The lower edge is linked using ordinary couplers. Doing this at a number of different places will cause the truss to bend in what could be referred to as a positive sag. There will be no increase in strength and neither will the sag be any smaller, but the positive sag will compensate.

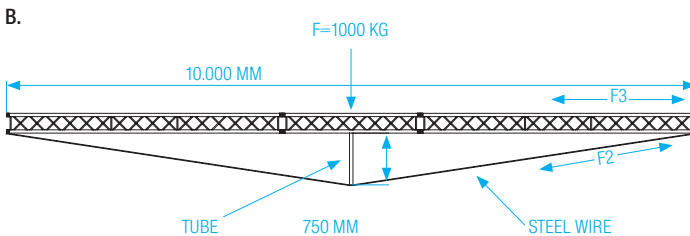

$F_2 = \text{STEEL WIRE ROPE} = \pm 2823\text{ KG}$   
 $F_3 = \text{TRUSS} = \pm 2780\text{ KG}$

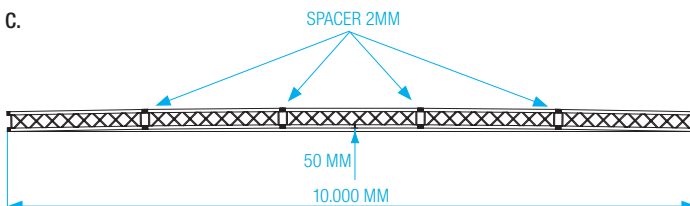





When rigging in relatively low venues or on outdoor stages, it is very important to have a clear set of references regarding heights. In this chapter we will explain a few of the "heights" that one may encounter, and what may be understood by them. As many of these terms are not yet defined in any entertainment rigging standard, one must always check whether there is a common understanding of the terms and if they are used correctly in relation to the show-designer's requirements.

### Lifting height

This refers to the length of lifting chain of the chain hoist; i.e. the amount of free chain needed at the life-end to do the lift, and at the dead-end to ensure proper pulling of weight on the chain into the chain bag when pushed out of the motor. Another important factor is the number of falls of the lifting chain.

### Example:

A 20 m lifting chain of 1 ton capacity reefed into a single fall 1 ton motor, with a 0,2m travel path through the hoist across the sprocket wheel and leaving 0,4m at both the life- and dead-end of the chain, will provide a maximum lifting height of approximately 19m. Here the 'motor down' type of hoist will stay at rest in the flight case and the weight of the chain motor does not need to be lifted out. In case a 20m lifting height is required, the hoist should be equipped with approximately 21m of lifting chain as a consequence. Likewise, a forklift has a specific lifting height, which is less than the overall height of the fully extended telescopic sections.

### Note:

To find the required chain length for a tower system, the width of the top section needs to be added to twice the height of the tower, the required length inside and the dead-end part of the hoist. You can subtract the height of the truss that connects to the sleeve block from this height.

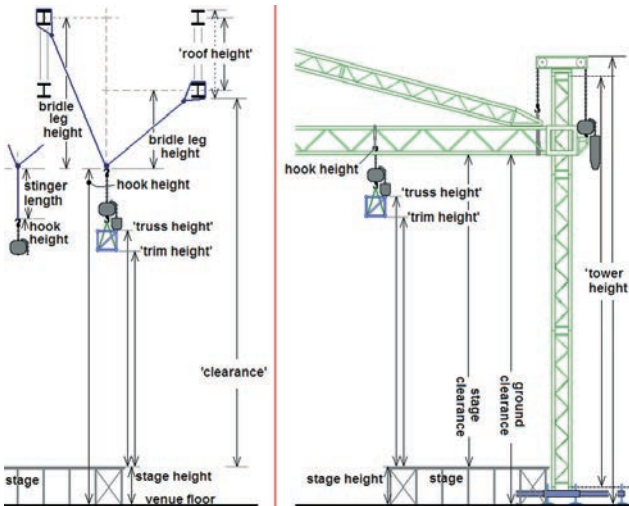

## 13. WHICH HEIGHT IS WHICH?

### **Tower height**

At Prolyte, tower height means the length of the tower trusses used as this is the actual working height of a system.

The “overall tower height” is of importance when erecting the tower.

### **Hook height (covered by NPR 8020-13)**

The hook height is often an important part of the rigging plot data. This term refers to the vertical distance between the venue floor and the required height of the upper hook. In a ‘motor down’ situation this refers to the chain hook.

The required hook heights are important when a master grid is the main part over those structures that need to be rigged for the show. Insufficient hook height options in a venue may result in adjusting the programmed travel distances of chain hoist movements, or even the focussing positions of the automated lighting equipment on the truss pods rigged from the master grid.

Depending on the height of the venue’s main structures, the hook height will set the attachment point in the bottom of the bridle.

### **Trim height**

The term originates from the theatre, and refers to the height where lighting instruments are cut from vision by a black textile border. In the majority of cases this will be the vertical distance between a specific part of an object (truss, set piece, PA cluster) and the venue floor.

Lighting designers mostly refer to the lower side of the truss (or a fly-bar in theatre) in relation to the stage surface, rather than to the venue floor.

Sound engineers may take a different view: some will refer to their top cabinets in a cluster or line array, others will refer to the clearance between the lower cabinets and the venue floor, which will be occupied by the audience. Decor designers mostly refer to the height of the lowest parts of the decor that must be clear from the theatre stage or studio floor in order to be hidden behind a border (horizontal black cloth), or to be cleared from view for a camera shot.

For a rigger, it is important to get the right kind of information in order to prepare, plan and rig the show safely and efficiently. He must verify these trim height data references with the specific designer he is rigging the equipment for.

### **Truss height**

Very often this has nothing to do with the lifting operation, but with the elevation of the truss module in the cross section: the X and H30V truss types have a truss height of 30 cm, and the S66V has a truss height of 66 cm.

#### **Note 1:**

Occasionally, the term ‘truss height’ may be used for the upper or lower side of the truss in its lifted position, so with a meaning more or less as in ‘trim height’.

Even so, if upper chords or lower chords are not specified, this could result in a ground support tower being one meter too low in case S100F or B100 type trusses are planned.

#### **Note 2:**

‘Trim height’ is also used in the automotive industry to indicate the clearance from the road to any part of the underside of the car.

Here the term is defined as ‘ground clearance’.

### **Clearance**

A general term referring to the unobstructed distance between the (stage) floor and the lowest parts of the main support structure.

Better wording would be ‘stage clearance’ and ‘ground clearance’ or ‘floor clearance’.

#### **Note 1:**

Manufacturers such as Prolyte provide information / data on ‘clearance’, meaning the distance from the venue floor ‘substrate’ to the lower side of the roof trusses, as the purpose or use and the height of a possible stage are not known. For outdoor roof manufacturers, ‘ground clearance’ would be a more regular term.



Photo: Walibi Holland

### Note 2:

In theatres 'clearance' may indicate the distance from the stage floor to the lower side of the fly bars.

### Roof height

This expression is also used in at least two different ways:

- A. as the distance between the venue floor and the lowest parts of main support structure ~ also known as 'beam height' and therefore almost synonymous to 'clearance'.
- B. The distance between the lowest and the highest parts of the main support structures, also referred to as 'roof structural height'.

### Note:

Structural engineers will refer to beams from the dead centre of the cross section, while in 'rigging' the tendency is to refer to the outer distances. The last dimension is important to clear the chain hook from the lower beam if the top chord beam is wrapped. The chain must be able to rotate freely and tip, whereas loading of the hook on a lower beam flange should be avoided at all times.

### Bridle height

Is the vertical distance from the top of the hook height (see: hook height) to the location in the structure where the anchorage points are fixed.

### Note:

The bridle height is important because, in combination with the horizontal distance to the main structure anchorage points, the lengths of the bridle legs can be calculated using the Pythagorean equation.

## 14. PROLYTE ROOF AND OUTDOOR STRUCTURES

### 14.1 INTRODUCTION

Temporary outdoor structures are widely used under all kinds of conditions and circumstances. Prolyte temporary outdoor structures provide a temporary roof above a mobile stage. This roof or temporary structure serves two main purposes:

- To provide shelter from environmental influences to people and equipment.
- To provide a support structure for commonly used equipment such as lighting, sound systems and scenery.

#### **Definition:**

Where this text refers to “the client”, this refers to several parties involved in the use, hire, renting or building of the structure, depending on the intended use, context and liability deriving from the actions mentioned in the text.

### 14.2 PRINCIPAL RESPONSIBILITIES

#### **General**

The general requirements for health and safety relating to demountable structures are the same as for permanent structures: a demountable structure should be part of a safe and healthy environment for those using it and should not give rise to risks to the health or safety of users, nor to those involved with the erection, maintenance or dismantling of the structure.

#### **Responsibilities of clients, venue owners and event organizers**

Primary responsibility for the safety of people attending an event and of the users of temporary demountable structures lies with the client. The client cannot pass on responsibility for safety to any third party. The client should make sure that competent people are employed to design, supply and erect temporary demountable structures. The client is responsible for assuring the safety of users of temporary demountable structures through the management and control of users before, during and after an event.

#### **The client must:**

- Make sure that requirements for safety in use are met.
- Make sure the contractor provides erection drawings and accompanying calculations, design loads and any relevant test results.
- Appoint a competent person to advise when appropriate technical expertise is lacking
- Give authorities adequate notice of the proposed use of the structure and when it will be accessible for inspection
- Have in place procedures for dealing with severe weather conditions during an event, including strong winds and heavy rain.
- Written method statements for erection and dismantling, including for methods of founding evenly on the ground, should be prepared by the contractor and given to the client for further transmission to all relevant parties, including the local authority, if required.

#### **Responsibilities of designers and contractors**

- Assess all the relevant scenarios to be certain that the accident risk has been taken into account.
- A risk assessment should be completed in all cases.
- Provide evidence of his/her competence.
- Carry out a final, independent check by a competent person, once the structure has been erected.

### 4.3 HAZARDS AND RISKS RELATING TO DEMOUNTABLE STRUCTURES

#### **Hazards**

The public expect safety in their day-to-day environment and do not take account of the risks that may be present. Hazards are generally defined as circumstances that have a potential to cause harm. A risk is defined as the likelihood that a hazard will be realized. The process of assessing hazards and risks deals with the questions: What if...? How likely is it that...? What are the possible consequences of...?

#### **Hazards during setup and dismantling**

Hazards caused during setup may result from factors such as human error, time pressure,



inadequate lighting, tired operatives and malfunction of equipment. If they are not detected, such hazards can present a danger to operatives erecting the structures and to users.

Hazards may also occur during dismantling. The principal hazards to safety during setup and dismantling include:

- Non-compliance with design and setup documentation.
- Non-compliance with good practice.
- Power or equipment failure.
- External event, e.g. fire, explosion, vehicle impact, wind, snow, earthquake.
- Falling from heights.

### Operational hazards

When setup is complete and the facility is open to users, a different set of hazards exists. If the facility has been properly designed and erected, such hazards will generally be the result of external influences. Pre-planning at all stages will minimize their effect. Principal operational hazards include:

#### Structural:

- Overloading, structural failure or collapse.

#### Vehicle impact:

- Extreme external events, e.g. flood, wind, snow, earthquake, lightning.
- Structural damage from any cause.

#### Crowd behaviour:

- Overcrowding.
- Vandalism or violent criminal behaviour.
- Excitement, demonstrations or incitement of a crowd; fire or explosion.
- Power loss leading to systems failures.
- Spillage of dangerous substances.
- Medical emergencies.
- Accidents.

#### Risk assessment

All employers are required to carry out an assessment to identify hazards and risks involved in the type of work that could cause injury to performers, employees or the public. Self-employed people are likewise required to carry out an

assessment of their work practices. Whenever significant changes are made to work procedures, those assessments need to be reviewed.

The risks associated with any given hazard depend on a number of factors:

- The probability of an incident and a series of secondary events occurring.
- The effectiveness of measures to protect against the hazard and to control an incident.
- The direct consequences if an incident occurs and the indirect consequences afterwards.

## 14.4 PROCUREMENT AND USE

### Specification of requirements

The client should provide the contractor for the demountable structure with a written technical specification of the requirements.

### Information checklist

Information provided by the client may include, among other details, the following:

- Site of event and location of the demountable structure at the site.
- Type and details of event, e.g. sports, theatre, festival, conference, concert.
- Programme for supply of structure, e.g. date required, date by which structural calculations and drawings are required for comment, erection timescale, any limit to working hours.
- Type of structure required, e.g. grandstand, marquee, stage; with/without roof.
- Size and weight of equipment to be supported by the stage and roof (where applicable).
- Accommodation needed on and in the structure, e.g. floor area, number of seats, sightlines, access to stage structure.
- Public access routes to site; public evacuation times during the event.
- Access to site for erection and dismantling.
- Ground conditions, e.g. flat or uneven ground, hard standing, soft ground.
- Enforcing authority contacts (building control, environmental health and fire officers) to ascertain licensing and approvals requirements.
- Fire risk factors.

## 14. PROLYTE ROOF AND OUTDOOR STRUCTURES

### Management checklist

The following requirements will help ensure that temporary demountable structures are procured and used efficiently and safely:

- Responsibility for design and erection of the structure and its foundations should rest with the contractor. People with suitable training and experience should carry out erection and dismantling. Design calculations and drawings or a type of approval, together with the independent design check, should be submitted to the client or client's agent.
- The structure should be designed by competent persons using accepted engineering principles and should comply with all relevant standards and guideline documents, as well as with the specification requirements.
- Any alteration should be subject to a further independent design check.
- The contractor and the event organizer should be able to provide proof of public liability insurance cover.
- The structure and its foundations should be protected from vehicular traffic, where necessary.
- After it has been erected, the structure should be subject to a documented erection check by a competent person.
- The structure should be maintained to be fit for use at all appropriate times.
- The client should carry out or arrange for others to carry out periodic inspections and require the contractor or other competent person to undertake appropriate repairs and remedial work as necessary.

### Compliance with regulations

It is always the client's responsibility to contact the enforcing authority to inform it of proposals for a temporary structure, and to seek advice on responsibility as regards any requisite enforcement, certificates, licenses and permissions, as well as regarding any special local regulations that may apply. Where an event is required to be licensed, the enforcing authority will check the calculations and drawings. When applying for a license for an event, the client should notify the enforcing authority about which contractor(s) will be supplying the structures.

The enforcing authority will then ask the client for the required technical information. It is the client's responsibility to supply all technical information requested by the enforcing authority in good time before erection starts. Enforcing authorities should raise any queries on the design sufficiently ahead of the start of erection to give the contractor time to deal with any problems. This is a key requirement for any risk assessment and method statement. Design documentation and technical information should in general be provided at least 14 days before erection starts, and the enforcing authority should respond in writing at least 7 days before erection starts. However, by their nature, temporary structures must often be supplied at very short notice. It is not unusual for an enquiry to be made, an order placed, the structure erected, the event held and the site cleared, all within less than a week.

The enforcing authority may also wish to inspect the structure during and/or after erection to verify that its construction complies with the approved details, that it does not obstruct any exit routes and that, insofar as is reasonably practicable, it does not lend itself to misuse by the public.

### 14.5 USE

#### Supervision during the event

Key aspects that should be considered in planning supervision during an event include the following:

- The safety coordinator should monitor the event and take action as necessary to make sure that demountable structures are used as planned and that safety is not compromised or jeopardized.
- Users should not be admitted to a demountable structure until the safety coordinator is satisfied that it has been properly erected and complies fully with the design criteria.
- No structural members forming any part of a temporary demountable structure should be removed during use.
- The number and distribution of users for which a structure has been designed should not be exceeded.
- Sufficient stewards should be appointed to each structure by the client to safeguard spectators.

BEAUFORT SCALE						
WINDFORCE [BEAUFORT]	WIND SPEED [m/s]	wind speed km/h	Wind speed MPH	Wind pressure $q$ [kN/m <sup>2</sup> ]	description	specification on land
0	0-0.2	0 - 0.7	0 - 0.43	= 0	Calm	Smoke rises vertically
1	0.3-1.5	0.8 - 5.4	0.5 - 3.36	≤ 0.001	Very light	Direction of wind shown by smoke drift but not by wind vanes
2	1.6-3.3	5.5 - 11.8	3.37 - 7.33	≤ 0.007	Light Breeze	Wind felt on face, leaves rustle, ordinary wind vane moved by wind
3	3.4-5.4	11.9 -19.4	7.34 - 12.05	≤ 0.02	Gentle Breeze	Leaves and small twigs in constant motion, wind extends light flag
4	5.5-7.9	19.5 - 28.4	12.06 - 17.65	≤ 0.04	Moderate breeze	Wind raises dust and loose paper, small branches move
5	8.0-10.7	28.5 - 38.5	17.66 - 23.92	≤ 0.07	Fresh breeze	Small trees in leaf start to sway
6	10.8-13.8	28.6 - 49.7	23.93 - 30.88	≤ 0.12	Strong breeze	Large branches in motion, telegraph wires whistle
7	13.9-17.1	49.8 - 61.6	30.89 - 38.28	≤ 0.18	Near gale	Whole trees in motion, inconvenient to walk against wind
8	17.2-20.7	61.7 - 74.5	38.29 - 46.29	≤ 0.27	Gale	Twigs break from trees, difficult to walk
9	20.8-24.4	74.6 - 87.8	46.30 - 54.56	≤ 0.37	Strong gale	Slight structural damage occurs, chimney pots and slates removed
10	24.5-28.4	87.9 - 102.0	54.57 - 63.38	≤ 0.50	Storm	Trees uprooted, considerable structural damage
11	28.5-32.6	102.1 - 117.4	63.39 - 72.95	≤ 0.67	Violent storm	Widespread damage
12	35.8			0.80		
13	32.7-36.9	117.5 - 132.8	72.96 - 82.52	≤ 0.85	Hurricane	Widespread damage
14	42.0	151.2	94	1.10		
14	45.6	164, 16	102	1.30		

$$V \text{ [m/s]} = \sqrt{(km/h) / 3.6}$$

Wind speed

$$q \text{ [kN/m}^2\text{]} = V^2 / 1600$$

Wind pressure



### Electrical installations and lightning protection

Electrical installations in temporary structures should be adequately earthed in accordance with normal standards. Consideration should be given to the degree of exposure and likely risk of strike by lightning and, where appropriate, the structure itself should be adequately bonded or earthed.

Advice on earthing and lightning protection should be sought from an electrical engineer.

In ground-supported constructions the main grid is quite often isolated to the towers because of the use of plastic or rubber castors in sleeve blocks. Thus the main grid needs to be earthed separately.

### 14.6 GROUND AND SITE CONDITIONS

The allowable bearing pressure on the ground is the pressure that can safely be applied to the ground.

The type and stability of subsoil are of significant importance to the allowable bearing pressure.

Particular care should be taken for:

- Ground conditions after heavy rain.
- Frozen or dried out surfaces.
- Bituminous, concrete or similar hard standings, the thickness and type of underlying material are critical to the ability of the surface to support load.

### Wood pads/spreaders

The normal method of supporting temporary demountable structures is to place timber spreaders on the ground and then use scaffolding screw jacks with soleplates to level up the structure. Special heavy-duty baseplates are sometimes used for temporary demountable structures; these are larger, stiffer and stronger than conventional scaffold.

Experience has shown that timber spreaders may be placed directly onto grassed surfaces underlain by ground of adequate bearing capacity. However, wherever structures are placed on grassed slopes, the turf/topsoil should be excavated locally to provide horizontal bearing beneath the spreader. Baseplates and spreaders should be engineered and their size and distribution not left to chance. Design calculations should be prepared to show how the leg loads are transferred to the ground. Experience has shown that the use of either scaffold boards or railway sleeper spreaders is generally satisfactory.

Concentrated soleplate/baseplate loads should be assumed to spread through the timber spreader at 2 horizontal to 1 vertical along the grain, and 1 to 1 across the grain unless directed otherwise by calculation. For heavy leg loads, the provision of a grillage of spreader timbers may be necessary. The contractor should inspect baseplates for damage before each use.

They should be positioned centrally under the load unless indicated otherwise in the design documentation. Failure to comply with this requirement may result in bearing stresses far in excess of calculated values, leading to local overstress of the ground and unacceptable differential settlement of the structure.

### Ground anchors

Several types of proprietary ground anchor are available. Manufacturers of ground anchors usually provide data on safe working loads for various soil types. It should be noted that these allowable loads vary considerably. Ground anchors should be designed by a competent person and installed in accordance with the manufacturer's guidelines and recommendations. Ground anchors can be difficult to install accurately. This can lead to eccentricities and give rise to bending moments in the structure or in the foundations that need to be accounted for in the design.

### Sloping ground

In general, it is not recommended to build temporary structures such as roof systems on uneven grounds due to the fact that this can cause massive erection difficulties as well as instabilities in the structure during erection and/or dismantling. Where a site slopes or is uneven, it will be necessary to either make the ground flat or to erect a structure that is capable of being modified to deal with the unevenness. Where the ground is not level or near level and the foundation bases for the structure cannot be set at an angle, a level base should be provided. This may be done either by cutting steps into the ground or by laying timber sleepers up the slope with timber blocks, shaped to match the slope and fixed to the sleepers to form individual foundations for each upright. It should be noted that the bearing capacity of foundations on a





Photo: Space Roof Training Scenbyggarna

step is reduced proportionate to the slope of the surrounding ground. This reduction should be accommodated in design. A competent person should furthermore check the stability of the sloping ground.

#### 14.7 WIND CONDITIONS

The influence of wind on a temporary demountable structure is one of the greatest dangers. Therefore, it is of primary importance that all measures mentioned in the static report are applied. The non-skilled omission of ballast, guy-wires or other construction parts can have major consequences for the security of all people concerned.

When using a temporary demountable structure, consulting local bulletins and/or applicable websites on a daily basis and taking precautions if necessary is therefore recommended. It is permissible to reduce wind loadings on temporary demountable structures if canopies and scrims can be taken out within a certain time frame; 10 to 15 minutes seems to be adequate. In general, these precautions are taken from winds speeds above 20m/s / 74 km/h / 46mph. Wind speed should be measured at a height of 10m above ground level, or at least at the highest point of the structure.

#### Use of scrim

The use of permeable scrim for every outdoor structure needs special attention. Quite often, permeability is expressed in a percentage related to light transmission. It should be noted that this is not the same thing as wind permeability. Scrim should be supplied with a CF number (aerodynamic resistance) for permeability. The type of fabric, its structure and the size of the openings determine this factor. In practice this implies that scrim may look open but is not with regard to wind.

Special acoustic scrims are available for sound wings. Most 'standard' scrims deform sound dramatically as they let the wind pass through.

#### 14.8 SETUP, INSPECTION AND DISMANTLING Preparation

The critical setup stages for temporary demountable structures should be identified during the design process. To ensure adequate provisions against overturning during erection, temporary strutting and/or guying may be necessary; such requirements should be adequately communicated to the site operatives.

## 14. PROLYTE ROOF AND OUTDOOR STRUCTURES

### Work site safety

The structure should be erected safely in accordance with the manuals and drawings provided. All Kent ledges, temporary guying and other means of temporary support identified in the manual should be properly installed to provide for the safety of operatives. All work at height must be fully assessed and carried out in compliance with the local or international requirements. Care should be taken to use the correct component in the correct location and orientation. All components should be carefully aligned. They should not be bent, distorted or otherwise altered to force a fit. Particular attention should be paid to lightness of connections. The torque applied to bolts and other connectors should be in accordance with the manufacturer's recommendations. Care should be taken to ensure that all ties and bracings specified have been correctly installed. Site alterations or adaptations to the specified design should not be made without the designer's verification.

### Guy-wires and connections

All necessary guy-wires and other components should be incorporated as assembly progresses. Guy-wires should be arranged to provide stability at all stages of erection. A check should be carried out to ensure that the necessary connections are made and that linking components are not strained to achieve engagement.

Local instability that might endanger the complete structure when loading occurs could arise through omitting or failing to tighten a bolt. Constant emphasis should be placed on the importance of paying attention to detail.

### Safety of operatives

Following the guidelines for the safety of operatives involved in construction work is recommended. PPE, including fall arrest equipment, should be used where appropriate. Suitable anchorage points should be identified in the design.

### Inspection of structures

Inspection is essential to maintaining the safety and integrity of a demountable structure. Inspections are required at various stages and are mainly the responsibility of the contractor. The client, safety

coordinator and local authority may also make inspections. The contractor should make regular inspections during setup to verify the design assumptions and to check that work is being carried out in accordance with the documentation provided. The initial inspection should concentrate on setting out and site preparation. Subsequent inspections should check the orientation and location of the components, especially bracing members, the use of temporary supports and the proper installation of the correct connectors, couplers and fittings. All inspection work should be documented. Specific reference should be made to remedial measures identified as being necessary and to dates agreed for carrying out such work. The contractor should carry out any remedial work deemed necessary by these inspections, unless he can provide documentary evidence to show that the as-built situation is safe.

### Local authority

Where a local authority license is required, the local authority inspector should be provided with a full set of documents for the assembly of the temporary structure and may inspect it at any stage. Such inspection will pay particular attention to site preparation and the fully assembled structure. The inspector may also require copies of any formal documentation of previous inspections.

### Setup check

After setup, the structure should be subject to an erection check by a competent person. The inspection should be followed by a systematic local check of the complete structure. A drawing and checklist should be available for continuous reference. The inspection should check that:

- Setting out is accurate within the tolerance required.
- The foundations are adequate, that they are not likely to be disturbed and that they and the lower portion of the supporting structure are not liable to damage by interference, accident, traffic, scour, undermining or any other cause.
- Suitable baseplates/spreaders have been provided, properly levelled and, where



necessary, adequately supported.

- The baseplates/spreaders have been properly bedded down, with no unacceptable settlement.
- Members are correctly positioned and connected.
- The stipulated limits of extension of adjustable components have not been exceeded.
- All required components, including pins, bolts, nuts, clips etc., are of the correct type, have been correctly inserted and are secure.
- Decking, seating and guardrails have been correctly installed and are secure.
- Services to the structure do not in themselves create a hazard or impose loadings not catered for in the design.
- On completion of a satisfactory inspection, the client should be informed and confirmation made in writing. After the structure is completed and inspected, it should be secured to prevent vandalism.

Measures should be taken to prevent unauthorized access beneath the temporary structure. It is recommended that a competent person inspect each structure while it is in use, with the frequency of inspections depending on the nature of the event. If a structure remains in use for a longer period of time (e.g. for a series of concerts at a festival), it should be inspected before each use.

### Dismantling

The process of dismantling a demountable structure is important since its components are likely to be reused. Care should be taken to maintain the safety of the dismantling team and other people nearby. Any temporary guying used to erect the structure will therefore be required when dismantling. This should prevent components from being bent, distorted or overstressed during dismantling. Minor damage to the structure may have occurred whilst in service, and damaged components should have been clearly marked in advance for ease of identification when dismantling.

During dismantling, the contractor should examine all components for signs of wear, deformation or other damage.

Damaged components, or those with temporary repairs, should be set aside for rejection or permanent repair offsite.



### Inspection of components

Repeated use of demountable structures will inevitably lead to general wear and tear on top of the damage or distortion that may occur during handling, transportation, assembly and dismantling. The contractor should regularly inspect all components used in demountable structures – including both erection aids and components of the structure itself – for signs of wear, deformation or other damage.

Such inspections should be carried out at the following stages:

- When allocated at the stockyard.
- On arrival onsite or during unloading.
- During assembly.
- Whilst in service.
- During dismantling.
- On arrival back at the stockyard.

## 14. PROLYTE ROOF AND OUTDOOR STRUCTURES

### Typical damage can include:

Tube and prefabricated components:

- Corrosion, cracking, deformation, creasing, split ends, non-flat or non-square ends, weld integrity.

### Connectors, couplers, fittings:

- Deformation, distortion, damaged threads.

Please refer to specific rejection criteria for components supplied by the manufacturer.

### 14.9 IDENTIFICATION

#### Structure components

All Prolyte trusses, towers and components are individually marked and can be identified by a type shield. Make sure these stickers are on the product. Overview drawings show where each component goes in the built construction.

#### Canopies

Prolyte canopies are generally made from fire retardant PVC. Identification marks are stamped in the material and printed on the label. Certificates for different countries are available upon request.

### 14.10 ASSEMBLY

#### Canopy

Over-tensioning should be avoided as this reduces the lifespan of the canopy dramatically and can result in excessive stresses in the main grid trusses.

#### Ballast

Ballast is the additional weight that is necessary to keep the structure in place and to secure it against wind forces, wind gusts, sliding or other hazards. The required weight can be different for each tower. For a list of the total amount of ballast needed, see the structural report.

In view of the various methods for applying ballast, as well as local legal restrictions, specific weight types are not shown in the drawings. However, ballast weight on tower bases is essential to ensuring the stability and safety of the system, and particularly in limiting climatic (wind!) conditions. The weight of an intermediate, interconnected construction or stage can be deducted from the

total required ballast loading, provided the stage is capable of bearing the horizontal forces, as specified in the structural report.

The stage must furthermore function as a single solid platform – meaning that the entire stage should come up when it is lifted at any corner. These requirements need to be checked by the stage supplier.

#### Lifting

The structural integrity of a temporary demountable structure is only guaranteed when completely built, meaning when all guy wires are in place and the ballast is connected. Integrity is not the same during lifting and lowering!

It is important to keep this in mind at all times. In general, Prolyte structures can be lifted and lowered at a maximum wind speed of 7.9 m/s (28.4 km/h / 17.6 mph).

When lifting the structure, one person should always be in charge of the lifting operation and one employee should monitor the lifting at each lifting point. Make sure there is good visibility at all times. Ensure that the capacity of your lifting device is adequate. We advise having at least 25% headroom in capacity. Unequal lifting, friction caused by sleeve blocks and uneven weight distribution can result in loads that are higher than foreseen.

#### Use of winches/hoist

Make sure to guide the wire-rope of the winch into neat side-by-side turns in smooth layers on the drum, as crossing cable turns cause severe damage and wear. Damage to wire ropes can lead to the breaking of wires, wire strands or even the whole cable, thus causing the sleeve block to fall, with a risk of property damage, personal injuries or even death.

When using a chain hoist, make sure that chains are free from twists at all times. Please make sure all points are lifted evenly and at the same speed. Intermediate checks or stops might be necessary to prevent uneven lifting of the complete structure.



## 14.11 INSPECTION

### General

Prolyte encourages the performance of carefully documented inspections by a competent person at least once a year, and more often if the circumstances or intensity of use require this. Responsibility and liability for the safe use of all temporary demountable structures lies predominantly with the client itself!

### Inspection levels

Both new and used truss modules should be inspected upon acquisition (initial inspections). Regular visual inspections should be carried out and a record of these inspections maintained. In addition, periodic inspections should be performed by a competent person prior to each use and at least once a year, or in accordance with an inspection routine established by a qualified person. Trusses subject to accident damage should be inspected in line with the requirements of periodic inspections.

### Permanent installations

Periodic inspections should be carried out on all truss modules that are permanently installed in a stationary (not subject to movement) configuration. The frequency of inspections should be determined based on the existing conditions. In the case of truss modules installed in a permanent configuration where movement of the truss system is an integral part of use, periodic inspections should take place every three months, or in accordance with an inspection routine established by a qualified person.

### Records

The owner should keep records of initial inspections and periodic inspections of each truss module, which should be signed and dated by the inspector.

### Repairs and removal from service

If any part of a truss shows significant visible damage or is suspected to contain a damaged element (visible or not), the truss should be removed from service and marked accordingly. A qualified person should carry out an assessment of the truss. Any module that contains damage deemed

irreparable should be permanently removed from use. Repairs should be carried out and warranted by either the manufacturer or a qualified person.

### Steel wires and chains

Inspection criteria and maintenance instructions for hoists, winches and all other rigging equipment are provided in the relevant manuals.



Photo: Tarzan the Musical

Moving people vertically is generally done with lifts, escalators, work lifts and hoisting platforms. The first two transport facilities are oriented towards the requirements for large machines that are open for general public access.

The last two facilities can be classified as working equipment for a select group of persons who have been instructed. Both types are regulated by a series of safety requirements and regulations which are clearly defined by law.

However, if the creative use of the flying movement of a person is in question, there is scarcely a country on earth that has a legally correct and clearly defined regulation.

For such special effects (used in film, TV and theatre) special people flying systems were developed for events technology.

Despite this fact, this manner of transporting persons is excluded from the Machinery Directive (2006/42/EG).

In the case of persons being lifted by devices that were not originally intended for this purpose, the requirements of the Machinery Directive are quite clear: double the safety factor. Generally this means

raising the safety factor from 5 to 10 or reducing the nominal load (WLL) x 0,5.

This proof can be provided by a manufacturer, for example, by a sort of design test by the TÜV and the subsequent identification of the trusses. Prolyte has design tests for all truss types.

Very detailed and specialised knowledge is required for flying performers. We strongly recommend engaging only companies which specialise in these types of projects.

Furthermore a technician should test thoroughly all components of a flying system and document the results of these tests. Before taking such a system into operation, an overload test and acceptance test should be performed. A risk assessment evaluation must be performed and the hazards for persons documented and measures to prevent this given. Furthermore, a practicable emergency plan must be drawn up, e.g. in case of a power cut.

We strongly recommend the Dutch code of practice NPR 8020-11 "Manual Driven Performer" Flying"systems"



Photo: Interstage, Festival Classique

SAFETY FACTOR	STATIC LOAD NO PERSONS UNDER LOAD	STATIC LOAD PERSONS UNDER LOAD	DYNAMIC LOAD PERSONS UNDER LOAD	STATIC LOAD PERSONS ON OR ATTACHED TO LOAD (A)	DYNAMIC LOAD PERSONS ON OR ATTACHED TO LOAD (C)
NOMINAL LOAD	✓				
0,5 X NOMINAL LOAD OR EQUIVALENT SECUNDAIRY SUSPENSION		✓	✓	✓(b)	✓

A) Examples: Focussing lights from the truss, the use of follow spot chairs or platforms for technical equipment.

B) Persons on the load need to take precautions against the risks of falls from height.

NB: The consequences for the static loading, as a result of climbing the construction or the absorption of forces resulting from fall arrest equipment need to be taken into account (EN 795)

C) Examples are: ballet, presentation on a lifting platform, installations for Performer Flying, work platforms

In a working environment employees are obligated to wear Personal Safety Equipment (PSE). It's a misconception that only the persons who are working at height or working in a riskful environment must use PSE.

All personnel entering a working site must use PSE. This could consist of shoes with rubber soles and steel noses or hard heads. In many building sites it's obligatory to wear a yellow jacket, which is designed to attract more attention to the other people who are working on the building site.

Recommended PSE items are gloves, shoes with steel noses, a yellow jacket and a heard head.

The responsibility of the employer is to make sure all PSE items are available on site for every employee, and to check whether the employees wear and use this PSE.

It is the responsibility of the employee to take as little risk as possible during his work. For example, never stand underneath a roofing system or a load while these are lifted.

All the PSE are regulated according to the European Health and Safety Directive. Besides this European Health and Safety Directive there are many other regulations on Personal Safety Equipment, and each different regulation has its own role in the total working environment. Many of these regulations are locally imposed, which makes it quite impossible to mention all regulations. The most common regulations are listed below.

### **Working at height**

Working at height (over 2,5 m.) is very common in the entertainment industry, for example to focus luminaires or replace a broken bulb.

In the case of working at height, always attempt to undertake work without climbing, and attempt to obtain access to the working area using working platforms to decrease the risk this work involves. Sometimes climbing is inevitable in order to get access to a certain point in the roof or building structure. In which case always undertake your own risk assessment and try to find a solution involving as little risk as possible.

### **Climbing gear**

General regulations state that from a working height of 2,5 meter, the employee has to wear proper PSE, including a full body harness.

Employers are obliged to provide appropriate PSE for their employees. Freelance personnel should provide their own PSE.

For riggers and climbing technicians, the most important items of their PSE are: a full body harness in combination with a shock absorber and a fall arrest system.

There are many types of harnesses on the market.

For riggers and climbing technicians a full body harness, consisting of a full body harness and a seat harness, is recommended. The two parts of the harness are attached and thus designed to spread the forces of the fall over your entire body. Suspension position after a fall is calculated to maximise the chance of surviving.

In combination with a full body harness riggers should also use a fall arrest system.

The fall arrest system should be attached either to your front (chest) or back (shoulder blades) suspension point. The additional shock absorber should always be attached above the waist. We recommend that the fall arrest system be attached to a lifeline system, which is attached to a building or roof structure at any time. Attaching your fall arrest system to the truss can be a dangerous option, as most trusses are not designed to withstand the additional forces of a free fall.

### **Fall arrest system with shock absorber**

An essential part of the fall arrest system is the shock absorber. This shock absorber is designed to reduce the force of a fall to a maximum of 600 kg. Without the use of a shock absorber, the force caused by a free fall can easily increase to 25 times the self-weight of the person who is falling, depending on the length of the fall and the attachment to the structure.

(fall speed = 9,8 m/s<sup>2</sup>)

Any elastic movement in the suspension rope or the construction might reduce these rates, but only very limited compared to a shock absorber.

The possibility of surviving a fall without a full body harness and a fall arrest system is very low.





Any full body harness must comply with the EN 361 “personal safety equipment against falling”. The shock absorber should comply with Standard EN 355.

### Positioning equipment

Next to the fall arrest system the use of positioning equipment is also recommended. Positioning equipment normally consists of a rope or sling together combined with special climbing gear like carabiners or saflock (scaffold) hooks. The positioning equipment should always be attached to the ring on the seat harness and is mainly used to place yourself in a working position, without using your hands.

When the positioning equipment leaves room for a fall of over 0.5 meter you are obliged to attach the fall arrest system/shock absorber.

We recommend leaving the fall arrest system always attached to the lifeline or roof system, this will reduce the risk of failing positioning equipment.

The anchor point should never be below the waist of the person who is climbing, in order to keep the falling distance as short as possible.

When this anchor point is attached to the truss this anchor point should always be on the main chord and in a node point. The use of two separate anchor points leaves you always attached to the structure, even when you are changing the position of one of the scaffolding hooks.

### Hardhat policy

The use of hard hats is obligatory on many construction sites, as well as for climbing personnel. Hard hats should comply with EN 397 standards. Hard hats protect the head from injury by falling objects and impact with other objects during climbing or in case of a fall. Hard hats require a restrained strap cradle to prevent the helmet from being displaced during a fall.

### Climbing a truss structure

One of the most common misconceptions about climbing Prolyte trusses is that the MPT truss series are not suitable for climbing but the heavy-duty series are. It is important to be aware that in the majority of cases neither truss is capable of withstanding the forces of a free fall.

We advise you to suspend your lifeline system from the roof or additional structure and never from the truss grid itself, wherever possible.

Whenever you are intending to climb the truss rig, the weight of the technician must be included in the calculation of the system. This is not only the weight of the person itself, but also the reaction forces of an eventual fall, which is 600 kg. in the worst possible position - usually the middle of a free span.

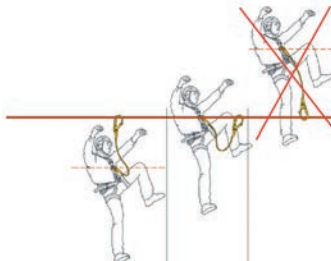

Fall arrest system with shock absorber



Shock absorbing Lanyard

## 16. PERSONAL SAFETY EQUIPMENT IN THE ENTERTAINMENT INDUSTRY

### Example:

For a single span supported on two hoists you need to determine if the truss span is capable of withstanding the reaction forces from the equipment suspended from the truss, plus the additional 600 kg, resulting from a free

fall (calculated as point load). Also the hoists should be able to take the resulting 600kg extra loading. Which is the case if you fall directly underneath a suspension point

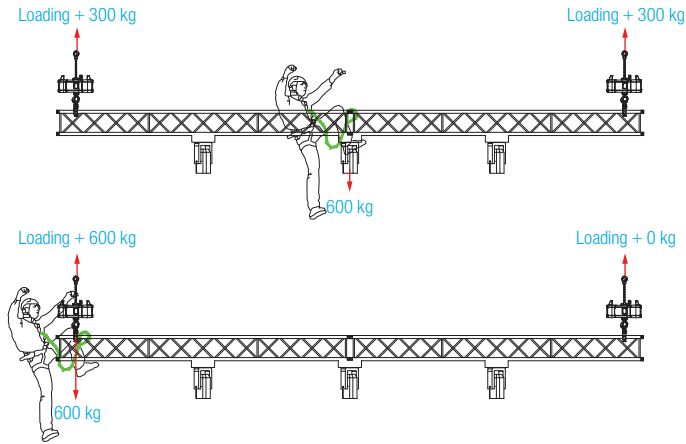

### Regulations

Most common regulations are listed here.

EN 361: 2002	Personal protective equipment against falls from a height - Full body harnesses.
EN 358: 2000	Personal protective equipment for work positioning and prevention of falls from a height - Belts for work positioning and restraint and work positioning lanyards.
EN 354:2008 2nd draft en	Personal protective equipment against falls from a height - Lanyards.
EN 355:2002 en	Personal protective equipment against falls from a height - Energy absorbers.
EN 813:2005 2nd draft en	Personal fall protection equipment - Sit harnesses.
EN 360:2002 en	Personal protective equipment against falls from a height - Retractable type fall arresters.
EN 363:2008 en	Personal fall protection equipment - Personal fall protection systems.
EN 795:2003 draft en	Protection against falls from a height - Anchor devices - Requirements and testing.
EN 1868:2003 draft en	Personal fall protection equipment - Definitions and list of equivalent terms.

- Draft versions are replacing earlier standards.



### 17.1 TRUSS APPROVAL

The use of trusses in the entertainment sector can be divided into two main applications:

- Truss used as a construction element.
- Truss used as lifting equipment.

Truss used as construction element, e.g. supporting structure for an exhibition stand or wall-mounted billboard frame is, in most European countries, subject to local building codes and is calculated in accordance with the applicable standards, such as Eurocode 9.

Prolyte trusses are calculated in accordance with the Eurocode 9 standards.

Prolyte truss also carries the CE mark. The European CE mark and is restricted to building materials only. It means that trusses and the materials from which they are manufactured are in compliance with the requirements.

A truss can also be used as a load-bearing element in combination with a lifting device. This application differs from the first because, in most cases, loads will be suspended above people or groups of people and this requires compliance with more stringent safety criteria. Moreover, trusses like those used in the entertainment sector are subject to wear and tear through repetitive use and handling. Compliance with CWA 15902-2 can be ensured by multiplying the safety factor with 1.2.

Prolyte has TÜV approval for most of its trusses. This approval can be acquired by checking calculations against the Eurocode standards and by a live test being carried out to assess whether the values are achieved. The test is not a value judgement.

If the manufacturer decides to lower its values for whatever reason, the TÜV will assess those values. This fact makes it difficult to compare load tables from different manufacturers.

Prolyte's policy has always been to be clear and transparent as regards the information it provides. That is why, a number of years ago, we urgently

requested that the TÜV state values including a safety coefficient for trusses on its certificates. Different brands of trusses can only be compared if these values are provided.

The details which a manufacturer has to be able to submit are:

- Material specs.
- Dimensions.
- Max. allowable bending moment.
- Max. allowable shear force.
- Max. allowable normal force in main chord.
- Max. allowable normal force in diagonal.

Prolyte is currently in the process of recalculating all its roofsystems according to Eurocode and obtaining a "construction book" for all its roofsystems.

### 17.2 INSPECTION LEVELS

#### Initial inspections

When first acquired, whether they are new or used, truss modules should be inspected in accordance with Table 1, and a record of the inspection maintained.

#### Regular inspections

Regular visual inspections should be carried out in accordance with Table 1. Regular inspections should be performed by a competent person and should be carried out prior to each incidence of use.

#### Periodic inspections

Periodic visual inspections should be carried out in accordance with Table 1 and a record of the inspections maintained. Periodic inspections should be performed by a competent person and should be conducted at least once each year or in accordance with an inspection routine established by a qualified person.

Trusses which are subject to any accident must be inspected according to the requirements per periodic inspection and in accordance with Table 1.

## 17. APPROVAL AND INSPECTION

### 17.3 INSPECTION FREQUENCY

#### Truss in regular service

Truss modules in regular service should be subjected to regular and periodic inspections.

#### Permanent installations, stationary

Periodic inspections should be carried out on all truss modules that are permanently installed in a stationary (not moving) configuration. The frequency of inspections should be determined on the basis of the prevalent conditions.

#### Permanent installations, moving

Periodic inspections should be carried out every three months, or in accordance with an inspection routine established by a qualified person, on all truss modules that are installed in a permanent configuration where movement of the truss system is an integral part of use.

### 17.4 RECORDS

Records of initial inspections and periodic inspections should be kept by the owner for each truss module and should be signed and dated by the person carrying out the inspections.

### 17.5 REPAIRS AND REMOVAL FROM SERVICE

- If any part of a truss shows significant visible damage or is suspected of containing a damaged element (visible or not), the truss should be taken out of service and marked accordingly. A qualified person should carry out an assessment of the truss.
- Any module that contains damage which is deemed to be unrepairable should be permanently taken out of service.
- Damaged modules should be clearly and permanently marked accordingly.
- Repairs should be carried out and warranted by either the manufacturer or a suitably qualified person.

TABLE 1

Part	Inspection level			Items to be inspected						
	Initial	Regular	Periodic	Chords	Diagonals	Connectors	Welds	Fasteners	Geometry	ID-TAG
	Chapter	Chapter	Chapter							
Missing parts				✓	✓	✓	✓	✓		✓
Dents	✓	✓	✓	✓	✓					
Bends	✓	✓	✓	✓	✓					
Holes (1)	✓	✓	✓	✓	✓	✓	✓	✓		
Incorrect repair	✓	✓	✓	✓	✓	✓	✓	✓		
Abrasion	✓	✓	✓	✓	✓		✓			
Corrosion			✓		✓		✓			
Missing members	✓	✓	✓	✓	✓	✓		✓		
Flatness (2)	✓	✓	✓			✓				
Deformation	✓	✓	✓			✓		✓		
Excessive wear	✓	✓	✓			✓	✓	✓		
Cracks	✓	✓	✓				✓			
Correct grading (3)	✓	✓	✓					✓		
Twisting	✓	✓	✓						✓	
Squareness	✓	✓	✓						✓	
Bending	✓	✓	✓						✓	
Sweep			✓						✓	
Camber			✓						✓	

(1) not to be part of the construction (2) particular for trusses with connecting plates (3) Minimum 8.8 grade



## Introduction

Apart from the normal requirements with regard to due care in utilisation, professional assembly, dismantling, transport and storage of trusses, regular inspections are vital. A careful visual check of the individual elements before each use, independent of the respective field of utilisation, should go without saying. Regular tests of the trusses should be carried out at least once a year by an expert and documented in written form. If the trusses are used intensively, regular inspections should be performed at shorter intervals. If deficiencies are noted during an inspection of trusses that preclude further safe use, the truss must then be discarded.

This means: render the product (here the truss) unusable for further use. Identification of the deficiency cannot be considered sufficient in most cases. Disposal via the manufacturer/supplier or a metal recycling company is the only safe way of protecting others from risks generated by defective material.

The criteria given here by Prolyte for discarding trusses should be incorporated fully into the inspection, since to date no official regulations exist within the EU.

## Scrapping criteria

Trusses are considered to be discarded if they display one or more of the following criteria. In case of doubt the manufacturer/supplier or an expert should be consulted for their opinion.

## General

- Missing identification (name of the manufacturer, truss type and date of production).
- Lasting (3D) deformation of the truss elements by rotation, bending or torsion or other deformation with resultant deviation from the original shape.
- Welds which have cracks or other irregularities. The incomplete welding seams around the diagonal braces are production-related and their adequate stability has been proved (TÜV design-tested).
- Incomplete welds (apart from the welds mentioned above in the chamfer area of the diagonal braces).
- Reduction of the raised level of the welding seam by mechanical wear by more than 10%.
- Excessive corrosion whereby the total cross-sectional area of the truss is reduced by more than 10%.

Although aluminium may not develop corrosion the way many steel alloys do, nevertheless ambient influences can have a corrosive impact on aluminium. Particular care should be taken with structures that are placed outdoors for a long time, especially in areas with a high level of industrial pollution. Trusses used near to the coast or close to swimming pools should be checked individually before each use due to the greater likelihood of these environments having a corrosive effect.

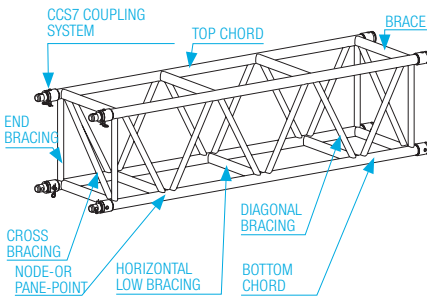

Elements of a truss.

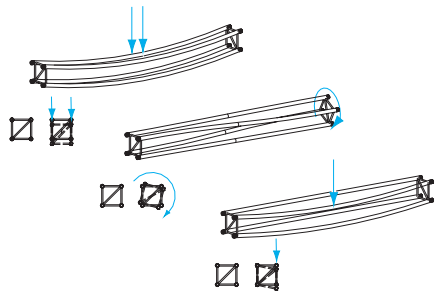

Types of deformation: deflection, torsion, rotation.

## 18. MAINTENANCE, INSPECTION AND DISCARD CRITERIA FOR TRUSSES

### Main chords

If one or more of the main chords breaks or shows cracks, or if one or more of the main chords is rolled by more than  $5^\circ$  from the original centre line then the truss is unfit for further use. The same applies if the ends of the main chord of a truss are rolled in the area around the conical coupler, connecting the truss to another element only possible by exerting considerable force.

### Further signs of a discard condition are:

- Scratches, cuts or signs of attrition on the surface of the main chords that reduce the cross-sectional area of the tube by more than 10%.
- Scratches, cuts or indentations in the main tube to a depth of more than 1mm and a length of more than 10 mm, irrespective in which direction.
- Holes which appear after the truss is brought into use.
- The remaining (plastic) deformation of the main chord to an oval shape or indentation of the tube by more than 10%.

### Braces

If one or more diagonal braces, end braces or cross braces is broken or no longer exists, the truss is not usable. The same applies for braces rolled by more than  $10^\circ$  of their diameter from the centre line.

Further signs of a discard condition are:

- Scratches, cuts or signs of wear on the surface of the braces that reduce the cross-sectional area of the braces by more than 10%.
- Scratches, cuts or indentations in the braces to a depth of more than 0.5 mm and a length of more than 10 mm, irrespective in which direction.
- Holes which appear after the truss is brought into use.

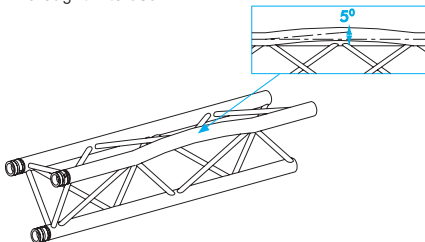

Bending of the main chords.

- The remaining (plastic) deformation of a brace to an oval shape or indentation of the brace tube by more than 10%.

### The conical connection system

Signs of a discard condition are:

- Cracked or partially broken welding seams between the main tube and the conical coupler.
- Oval signs of wear in the drillholes greater than 10%.
- Rotational displacement for the drillholes for the bolt holes in a CCS connector or between two adjoining connectors by more than  $2^\circ$ .

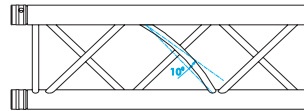
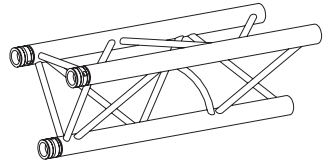

Bending of the diagonals braces.

- Deflection of the main chord ends with conical couplers by more than  $5^\circ$  which makes connecting two truss elements during assembly more difficult.
- Signs of wear on the conical connector or the conical coupler that reduce the cross-sectional area by more than 10%.
- Deformation or distortion in the main chord area next to the welds of the conical coupler.
- Overloading by excessive force causes buckling.
- Overloading through excessive tensile force can cause diminution of the main tube next to the welds.
- Each scratch, cut or hammer stroke indentation on the conical coupler to a depth of more than 2 mm and that is longer than 10 mm, independent of the direction.
- Excessive corrosion in the connection. For systems that have remained assembled for



more than one year indoors or for one summer outdoors, new, galvanised bolts should be used or stainless steel in order to prevent possible dangers by galvanic corrosion.

### Conical Spigot Pins

The conical spigot pins undergo wear when inserted and removed frequently, in particular by hammer strokes. They can be regarded as consumer goods. Pressure areas and deformations in the pins are indications of a massive overload. If a pin shows such a change, it may not be used any longer.

#### Further signs of a discard condition:

- An increase of the diameter by more than 10%.
- Cuts, indentations, scratches and other damages on the smooth surface of the pin.
- Burrs, mushroom heads and other protruding, sharp or pointed edges at the narrower end of the pin.
- Deformation through hammering which causes wear on the cross-hole or damage to a screw thread.

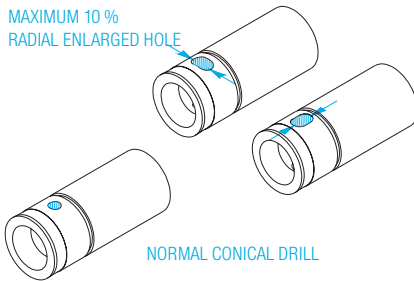

Deformation of the spigot holes.

- Attrition of the zinc coating on any part of the pin, causing this to corrode.
- No self-locking nuts may be used if the nylon safety mechanism is clearly damaged by wear.

### Documentation

The stipulation to inspect all trusses or tower elements every day is unrealistic. All truss and tower elements should be inspected carefully by a qualified person at least once a year

(if used intensively, this interval should be shortened correspondingly) in order to ensure the functionality and safety of the trusses.

These inspections should be documented in an inspection protocol containing the test criteria and results. Ideally every element should be given a distinct mark so that the maintenance history of each element can be followed. Discarded trusses must be removed from use immediately and marked so that they cannot be used mistakenly by other persons. If there is any doubt about the usability of a truss it should not be used under any circumstances. In such a situation contact your supplier.

### Maintenance and servicing

During these regular checks some defects can be remedied by professional inspectors. Aluminium can build up on the inner side of the drillholes of the conical couplers, which should be removed from time to time with medium grained sandpaper. Remains of spray paint, dirt, dust and fibres frequently collect on the conical couplers of the

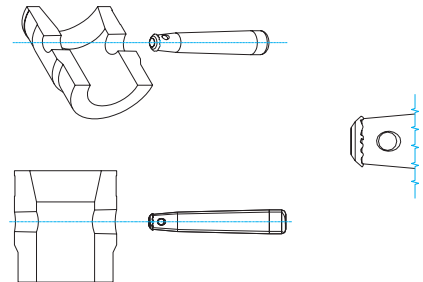

Deformation of the conical pins.

trusses or the tower and make assembling the elements more difficult.

Some companies use spray paint to mark their trusses. Care should be taken that no paint gets on the fitting surface (inner side and abutting face of the conical coupler, outer sides of the conical connector and inner sides of the drillholes for the conical pins), since the connecting elements are manufactured very precisely. Drops of paint

## 18. MAINTENANCE, INSPECTION AND DISCARD CRITERIA FOR TRUSSES

can be five times thicker than the manufacturing tolerances.

They can cause connecting elements to stick or interfere with assembly when they are dry. Prolyte recommends users use a copper hammer when mounting the conical pin.

This will preserve truss pins since copper is softer than steel, also soft copper prevents excessive damage if the incorrect place is struck on the conical coupler or the tube. "Mealy" residues on conical connectors and couplers are normal and can be removed with water and lint-free cleaning cloths. Aggressive cleaning agents should not be used under any circumstances, and certainly not acids. Exterior soiling of the trusses, e.g. with glue residues, can be removed with soap or pressure water guns. Cleaning cloths offered by adhesive tape manufacturers can be used if the manufacturer declares their harmlessness to aluminium alloys. Truss elements that are impaired in any way

### **ATTENTION**

If trusses and towers are not inspected regularly this can impair the safety of the products, risking damage to objects and injury or even fatal accidents to people.

from a safety perspective must be removed from use immediately so that they cannot be used by mistake. A strip of adhesive tape as identification is not sufficient because its meaning can be misunderstood and it can be overlooked or removed. Understanding of the safety aspects for trusses and truss structures is of course heavily dependent on adequate information and training being provided for the user.

Prolyte and all Prolyte dealers offer regular workshops and training courses on the safe handling of Prolyte products.

For more information see [www.Prolyte.com](http://www.Prolyte.com).

### **Repairs**

Repairs should be carried out and warranted by either the manufacturer or a qualified person.

### **Documentation**

It is the liability of the installer or supplier to provide sufficient information with the equipment you buy. Each piece of equipment should be delivered with a proper manual. If your supplier does not include manuals with their delivery, you should ask for them.

If the delivery includes installation of the (rigging) materials, the installer should also provide the following documents:

- IA complete manual for the installed system.
- IWorking and maintenance instructions.
- IStructural calculations.
- IRisk analysis.

Please be aware that these are not necessarily the same as equipment manuals from the supplier. An

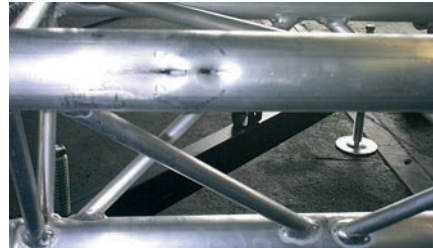

installation is regarded differently than the individual components within the installation.

All rigging and trussing equipment must be inspected and maintained on a regular basis.

Knowing where the equipment was made, when it was installed and its history will help you make informed decisions regarding frequency of service. It is the responsibility of venue managers and owners to have access to this information and to keep the documentation up to date. All inspection and maintenance services should be documented in a log.





Photo: Prolyte Campus event, Emsdetten, Germany

## 19. RULES FOR APPLICATION

We would like to provide some tips for using trusses in daily operation:

### Data acquisition

Loads to be applied:

- Number of the different single and span loads such as: floodlamps, moving lights, power supply units, follow spots (including seat and operator), cables, adapters, loudspeakers, loudspeaker cradles, projection screens, projectors, flying frames, curtains, backdrops, etc.).
- Mass/weight of the individual loads.
- Determination of the overall load.
- Number and type of supports.
- Number and distance of the flying points and their load-bearing capacity.
- Number and distance of columns and/or rigging points.

### Local circumstances:

- Access to the site.
- Potential equalisation.
- Communication paths with event organisers and authorities.
- Special local regulations (e.g. prohibition of special working materials).

### Selection of suitable trusses

Firstly the load for every individual truss span must be calculated. If a combination of uniformly distributed load and point loads occurs on a truss, the corresponding formulae should be used. The values for uniformly distributed loads and point loads should not simply be added together. The bending moments are highly dependent on the positioning of the loads.

NB: uniformly distributed lighting fixtures on trusses can be regarded more or less as uniform loads with the exception of follow spots lamps which have to be treated as point loads. The loads are compared with the allowable values according to the load tables for the corresponding truss types (the allowable structural data like bending moments can be found in the catalogues).

As the next step the self weight of the truss type for this application is determined.

The overall weight can be calculated from the length of the truss (including all connecting parts).

The overall weight is needed later to determine the reaction forces at the supports.

### Multiple supports

Firstly it should be determined how many supports will be needed to ensure adequate safety of the truss span if either the load is so high that the allowable bending moment is exceeded or a span with two supports exceeds the values in the table. The reaction forces are calculated from the self weight of the truss and the loads imposed. The corresponding formulae for trusses on two supports or for trusses on more than two supports (multi-span trusses) should be used. Next the required bearing capacity of the lifting equipment based on the reaction forces is calculated.

If loads are suspended over persons, suitable methods must be found to ensure that the failure of an overhead suspension does not place that person at risk (single failure tolerance). This shall be documented by a risk assessment.

### The reaction forces

The loads on the main structure are calculated as follows: For "flying" trusses: Add the self weight of the lifting equipment to the calculated reaction force, calculate the length of the steels (and from that the mass which is also added to the reaction force) as well as the horizontal forces in the rigging points caused by possible bridles.

For free-standing truss structures (ground support): Add the self weight of the vertical columns to the calculated reaction force and check the allowable effective length of the vertical supports. In addition the whole truss structure should be checked with regard to overall safety and stability. If needed, the appropriate braces or guy wires must be added. Checking the point loads of the rigging points in buildings: For "flying" trusses: Check truss joints, spans and corresponding rigging points for their bearing capacity. The data regarding the allowable joint and node point loads must be supplied by the operator of the event site.

For free-standing structures (ground support): allow for the bearing capacity of the floor area. The base of a truss is generally much less than a square metre, despite the baseplate. The information on the allowable floor loading must be provided by



the operator of the site. The rigger will perform the necessary corrections to prevent potential overload situations by modifying the position and number of the hoist devices or placing bridles.

### **Diagrams and tables**

All collated information and calculations must be recorded in written form so that they can be checked by structural engineers or authorities. Diagrams should show the position and identification of the suspension points and hoisting gear with the corresponding point load including the weight of the hoisting gear in kg or kN. Furthermore the diagrams must be to scale which must be given in the diagram.

The diagrams must also contain the allowable loads for the slinging points and the vertical slinging wires and bridles. Tables must contain all hoisting devices, all point loads, all slinging points and all vertical loads at the individual slinging points. The numerical values can be rounded up to the nearest 5 or 10 kg in order to allow for the weight of the slinging devices, shackles, rings, span clamps etc. that are not specified with all their details in the original weight lists.

### **Keep your knowledge up-to-date**

In writing and compiling this BlackBook, Prolyte has tried to offer a complete and up-to-date overview of current regulations and standards, however we can never guarantee that we can publish the latest developments directly.

Therefore it's always good to keep your knowledge fresh by staying in the loop of new developments and regulations by reading the multitude of articles, books and blogs that do appear regularly.

Furthermore you can attend the Prolyte Campus events, which are organized on a regular basis all around the globe. Prolyte Campus events aim to bring vital knowledge on trussing, staging and rigging to a wider audience to help you build things better and safer. Please look on [prolyte.com](http://prolyte.com), when and where you can find the next event.

Prolyte produces technical blogs, instruction videos and relevant information on a regular basis, or you can post your questions on our forum. Stay tuned on [www.prolyte.com](http://www.prolyte.com)



Photo: Prolyte Campus event at Prolyte Products GmbH

### PROLYTE CAMPUS: A LEARNING INITIATIVE

Prolyte Campus is a Prolyte Group initiative to support its customers with the best and most up-to-date knowledge available. Providing the tools and training to use the Prolyte Group products safely and in compliance with applicable standards and regulations will help you perform better. Prolyte Campus offers a complete program of learning activities to create awareness on the safe use of Prolyte products.

#### **Providing the knowledge to let your business grow**

As a manufacturer Prolyte Group feels the responsibility to supply knowledge as integrated part of its products. Creating the awareness that safe working practices are key to responsible ownership is one of our goals. Placing all our training initiatives under one umbrella is a means to facilitate access to this knowledge base for all our customers and users. Transferring knowledge and creating a dialogue with technicians worldwide, finding their needs and sharing experiences is a valuable base for creating solutions that work and help you grow your business.

#### **What does the Prolyte Campus offer?**

Sharing knowledge is the pivotal point, in whatever way is needed to get the message across. Prolyte Campus offers a mix of online, printed and seminar based means of knowledge transfer. Existing activities like the BlackBook, how-to videos, rigging courses and seminar opportunities, will be continued. New initiatives like web based learning content and networking opportunities will be developed. Prolyte users will be encouraged to share their experience and daily practice skills.

#### **Enroll in the Prolyte Campus**

Want to join this initiative? Share your ideas or experience on [www.Prolyte.com/prolytecampus](http://www.Prolyte.com/prolytecampus) participate in one of our seminar programs or organize one! You can find more info at [www.Prolyte.com/prolytecampus](http://www.Prolyte.com/prolytecampus) or contact [marketing@prolyte.com](mailto:marketing@prolyte.com) for any specific requests.



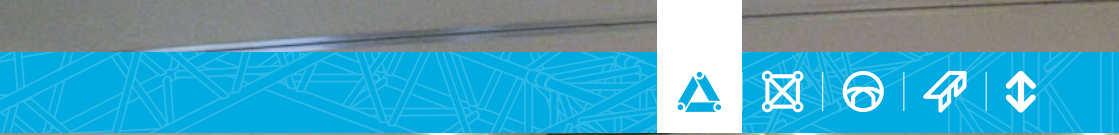

Photo: TSD Group, Prolyte Campus event in Argentina















## IMPRESSUM

### Text and translation:

Rinus Bakker  
Matthias Moeller  
Eric Laanstra  
Marina Prak  
Ivo Mulder

### Autocad Drawing:

Ivo Mulder  
Ralph Beukema

### Photography:

Prolyte Group  
Jan Buwalda  
Interstage  
Showtech  
Astana  
Perinic Sistemi

### Design:

Jeen de Vries

**Edition: June 2016**



Prolyte Group · salesnl@prolyte.com · +31 594 851 515